



BEAUBIEN DOUBLE SHADE



type	wall	
materials	shade :	powdercoated aluminium
	body :	powdercoated steel and aluminium
	hardware :	brass
	sphere :	milk glass (G50)
	canopy:	powdercoated steel
	wire:	nylon
weight	3.0 lb / 1.4 kg	
light bulb	LED (included), 2 x 3,5W	
sockets	G9	
voltage	120V / 240V	
dimmer	refer to our recommended list of dimmer models	
certifications	 	
notes	<ul style="list-style-type: none"> – must be installed by an electrician; – requires a wall electric box; – lead time between 8-9 weeks – dimensions are approximate and may vary slightly 	

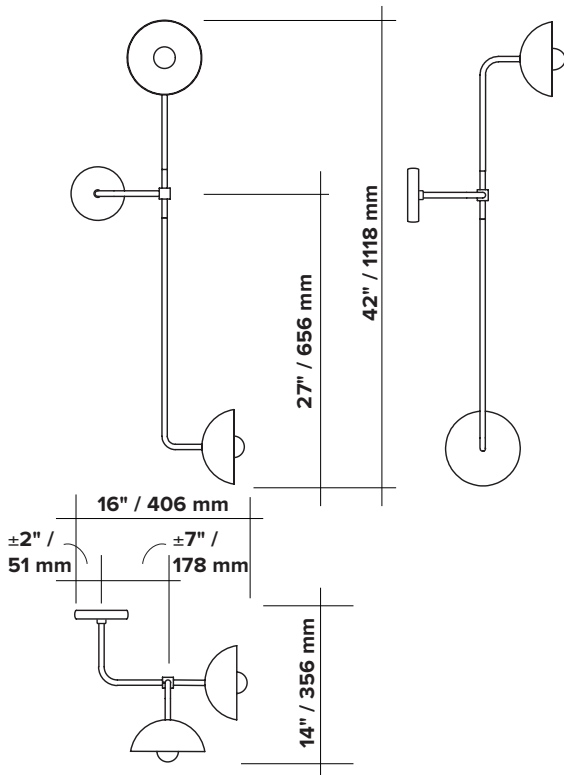

ORDER GUIDE: SKU

<u>COLLECTION</u>	<u>MODEL</u>	<u>FINISH (body + hardware)</u>	<u>INSTALLATION</u>
BEA beaubien	04	BLBR black body brass hardware	A standard
		BLGR black body graphite hardware	B reverse
BEA	04	BLBR	A = BEA04BLBRA example

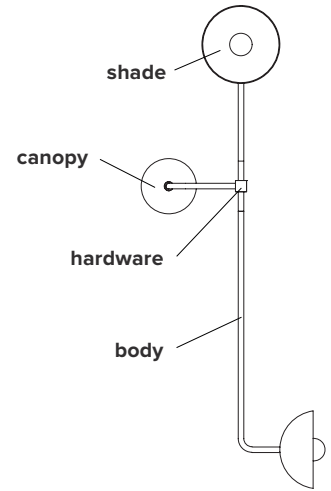

FINISH



brass



black



graphite

INSTALLATION

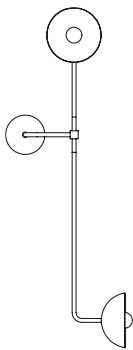

A - standard

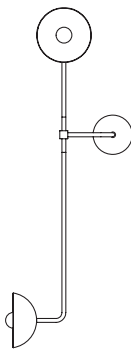

B - reverse

LIGHT BULB & DIMMER SPECIFICATIONS

G9 SOCKETS

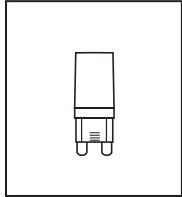

Frosted
3.5W
100V-120V / 240V
350 Lumens
2700 K
25 000 H
CRI ≥80
2 years warranty



SPHERES



G100 Ø ± 4" / 100 mm



G80 Ø ± 3" / 80 mm



G60 Ø ± 2" / 60 mm



G50 Ø ± 2" / 50 mm



tube Ø 1" / 27 mm
length ± 2" / 60 mm

DIMMER LIST COMPATIBILITY FOR G9 LED BULBS – 120V

The dimming technology offering the best results is ELV (electronic low voltage) dimmers with reverse phase or trailing edge control.

<u>DIMMER BRAND</u>	<u>MODEL NUMBER</u>	<u>MAX LEVEL</u>	<u>MIN LEVEL</u>	<u>FLICKERING</u>	<u>OVERALL QUOTE</u>
LUTRON - MAESTRO	MAELV-600	100%	0%	0%-10%	good
LUTRON - SKYLARK	SELV-300P	100%	0%	no	very good
LUTRON - SKYLARK	SELV-303P	100%	0%	no	very good
LUTRON - SKYLARK	CTELV-303P	100%	0%	no	very good
LUTRON - DIVA	DVELV-300P	100%	0%	no	very good
LEGRAND - ADORNE	TRUE UNIVERSAL	100%	30%	no	good

DIMMER LIST COMPATIBILITY FOR G9 LED BULBS – 230V

<u>DIMMER BRAND</u>	<u>MODEL NUMBER</u>	<u>MAX LEVEL</u>	<u>MIN LEVEL</u>	<u>FLICKERING</u>	<u>OVERALL QUOTE</u>
VARILIGHT	V-PRO	100%	2%	no	very good
LEGRAND - NILOÉ	3 996 35	87%	15%	no	good
NIKO	310-0280X	94%	5%	no	very good
NIKO	310-0190X	100%	1%	no	very good

*Other dimmers can yield good results and we recommend conducting your own test before final installation.