



nuda.

verumitaly.com/nuda

L'UNICA MANIGLIA SENZA ROSETTA THE ONLY HANDLE WITHOUT THE ROSE

Nuda è una collezione di maniglie che utilizza un innovativo sistema brevettato che ne permette il fissaggio senza rosetta, perfetto per un design minimalista.

Il montaggio avviene in pochi secondi senza necessitare di competenze tecniche o attrezzature specifiche.

Nuda è adattabile a ogni spessore e tipologia di porta. Le sue funzionalità sono garantite secondo DIN 1906.

La finitura Grigio Milano è realizzata con un trattamento antibatterico a protezione della superficie di ogni maniglia Nuda.

Nuda is a collection of handles with an innovative patented system whose assembly does not require anymore the rose.

A minimalist and design solution for any door. The assembly is very quick, it can be done in few seconds and it does not require any specific technical skills and tools.

Nuda can be adapted to any thickness and typology of door. The functionality of Nuda is guaranteed by DIN 1906.

Milan Grey finish has a special antibacterial treatment to protect the surface of any Nuda handle.

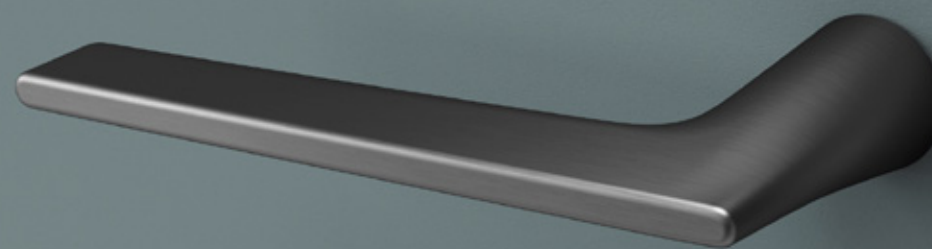
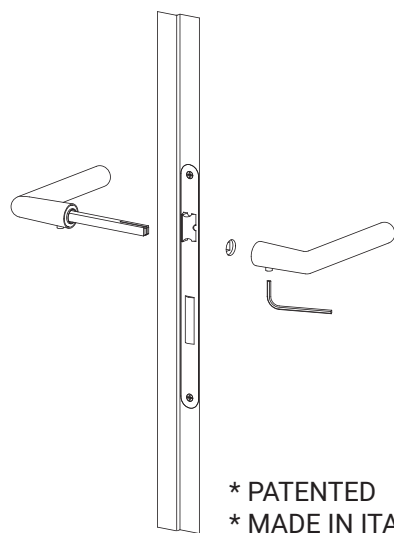

LE MANIGLIE
THE HANDLES

Pure ^{p.8}



Baar ^{p.10}



Lieve ^{p.12}



Pepe ^{p.14}



Wind ^{p.16}



Atlanta ^{p.18}



I POMOLI
THE KNOBS

Lui ^{p.20}



Cham ^{p.22}



Soap ^{p.24}



Pure

design Mattia Ferremi

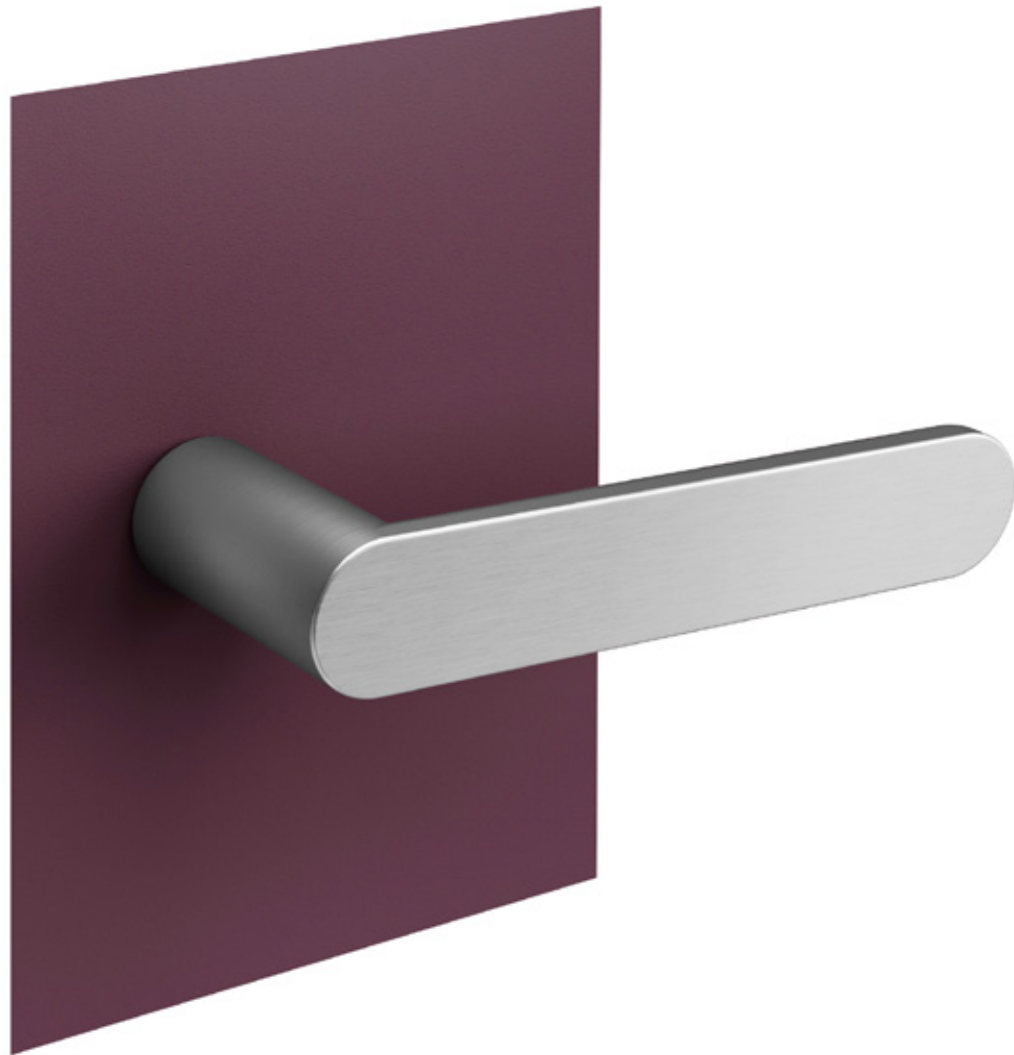

Cod. 127001
 Materiale Zama / Material Zamak

Porta door

132 25 50

Quadro Spindle \sphericalangle 8







Finestra window

24 152 64 10 60

Bocchette Escutcheons

26 42 26 42 1 4

FINITURE FINISHES

-  **Cromo Satinato**
Satin Chrome
-  **Cromo Lucido**
Polished Chrome
-  **Nero Etna**
Etna Black
-  **Bianco Monviso**
Monviso White
-  **Bronzo Yester**
Yester Bronze
-  **Oro 24 Kt**
Gold 24 Kt
-  **Grigio Milano**
Milan Grey

Baar

design Alessandro Stabile

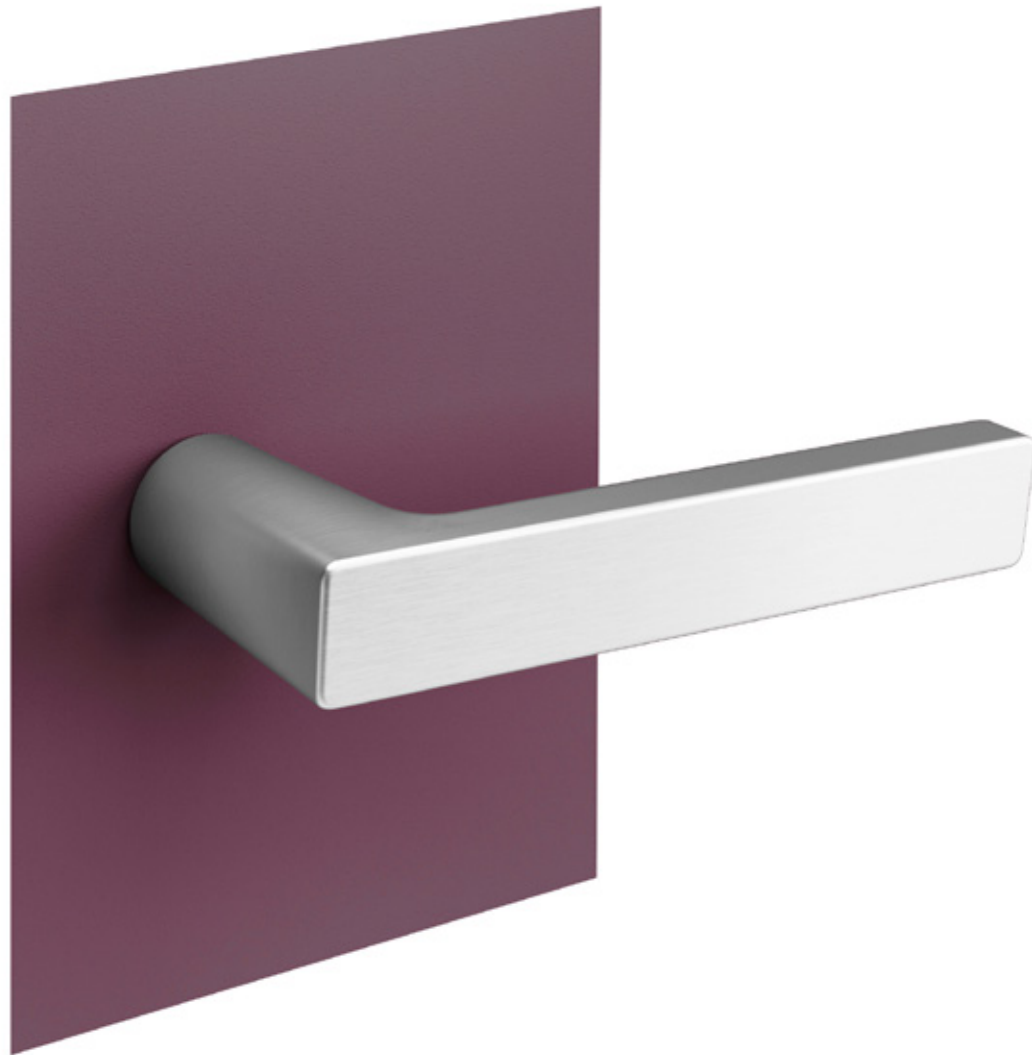

Cod. 127006
Materiale Zama / Material Zamak

Porta door

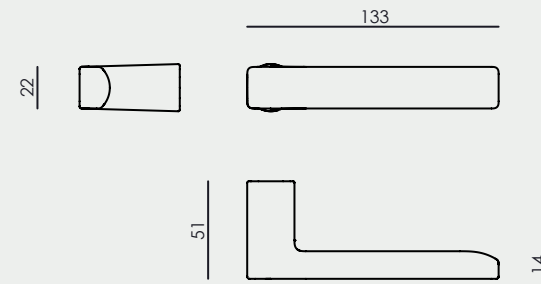

Quadro Spindle $\square 8$



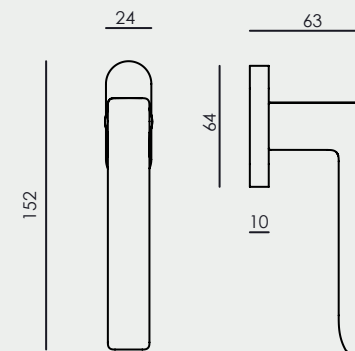

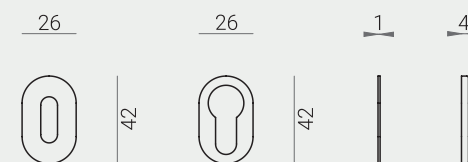

Finestra window



Bocchette Escutcheons



FINITURE FINISHES

-  **Cromo Satinato**
Satin Chrome
-  **Cromo Lucido**
Polished Chrome
-  **Nero Etna**
Etna Black
-  **Bianco Monviso**
Monviso White
-  **Bronzo Yester**
Yester Bronze
-  **Oro 24 Kt**
Gold 24 Kt

Lieve



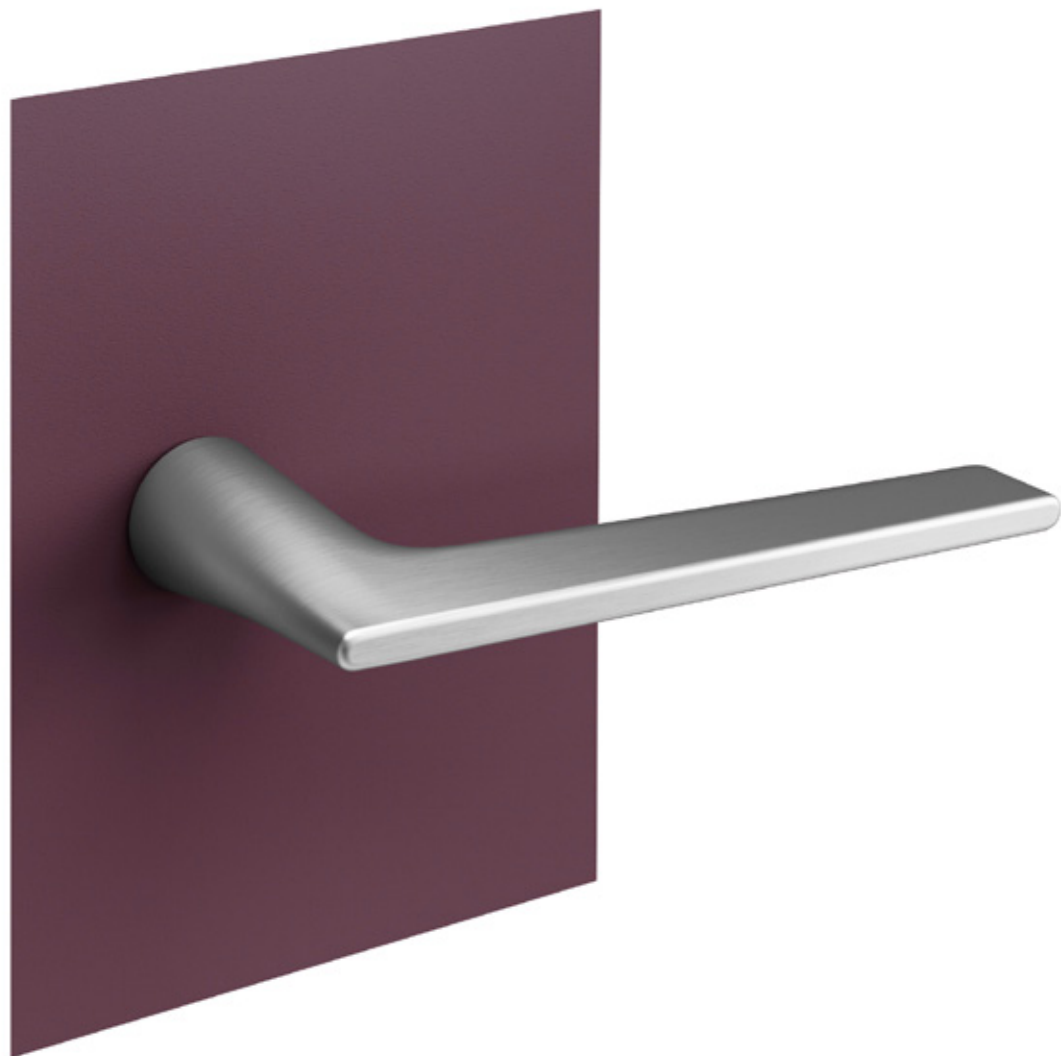

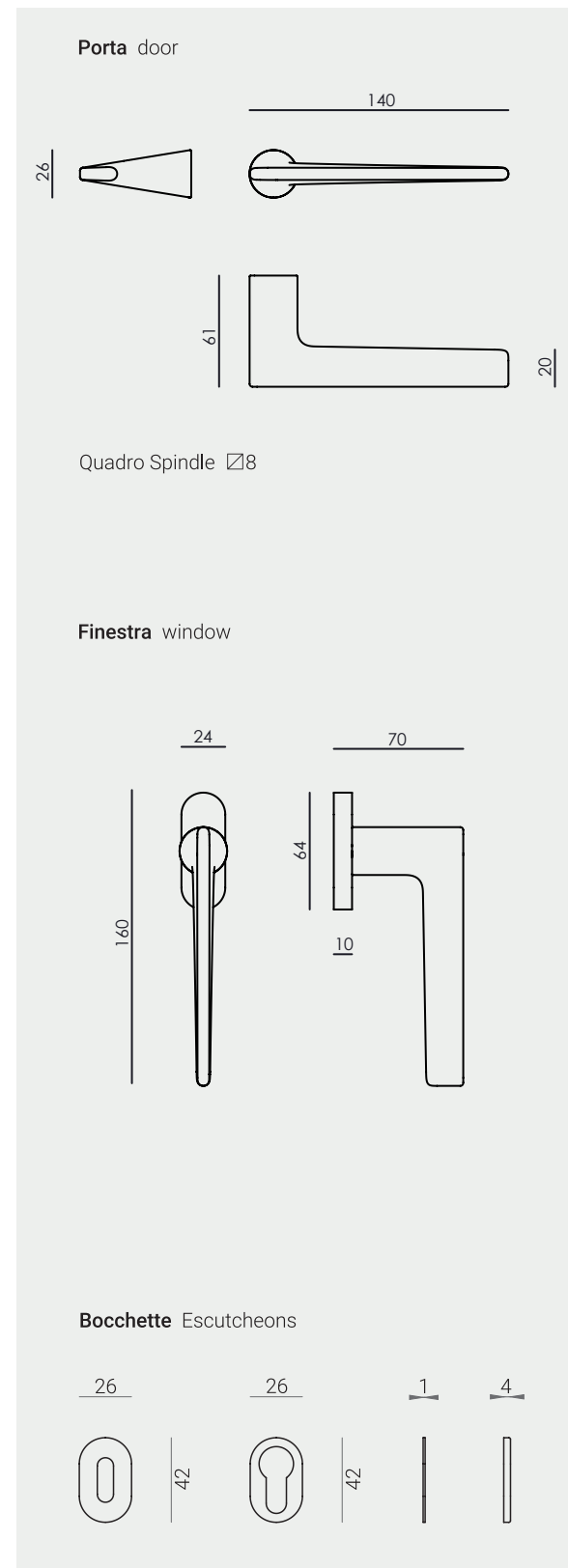

design Alessandro Stabile



Cod. 127005
Materiale Zama / Material Zamak



FINITURE FINISHES

-  **Cromo Satinato**
Satin Chrome
-  **Cromo Lucido**
Polished Chrome
-  **Nero Etna**
Etna Black
-  **Bianco Monviso**
Monviso White
-  **Bronzo Yester**
Yester Bronze
-  **Oro 24 Kt**
Gold 24 Kt

Pepe

design Alessandro Stabile

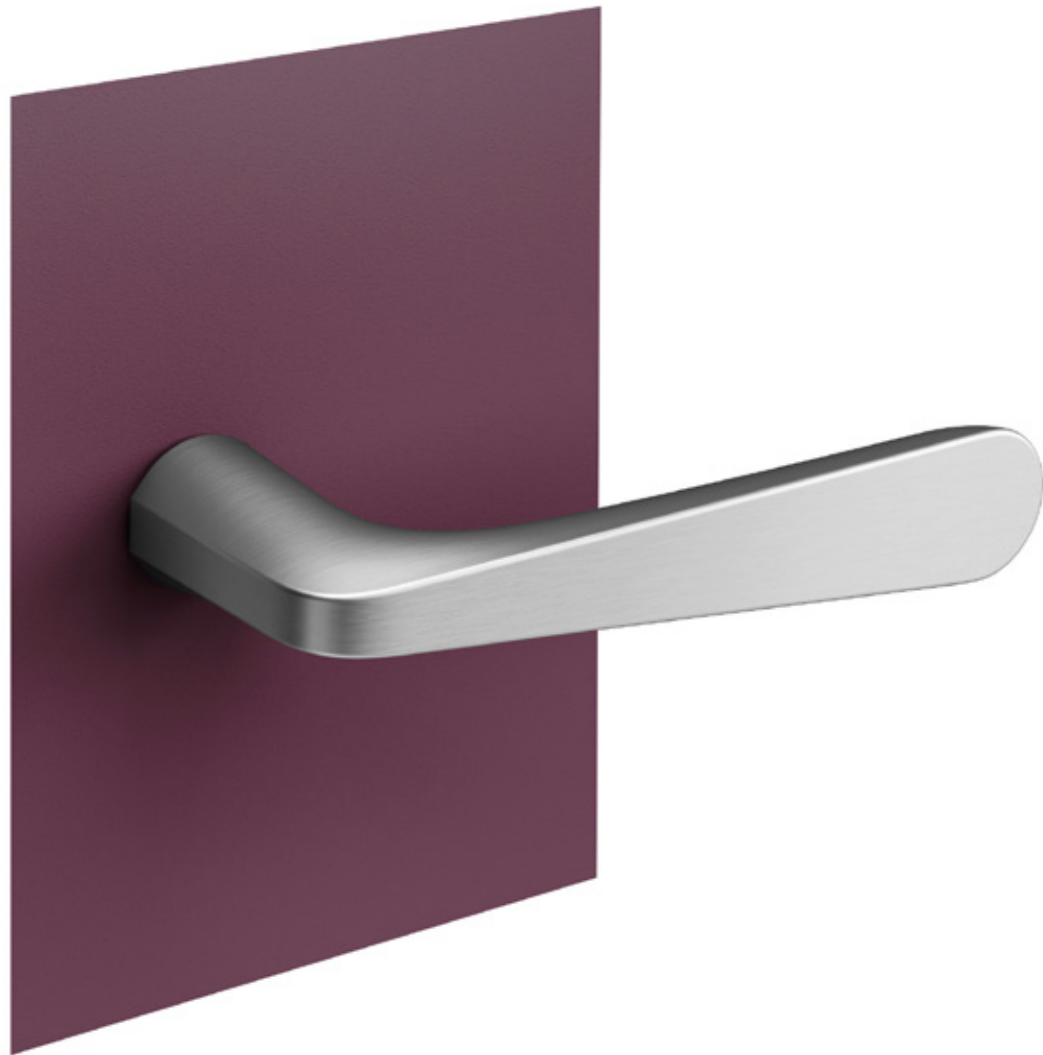

Cod. 127007
Materiale Zama / Material Zamak

Porta door

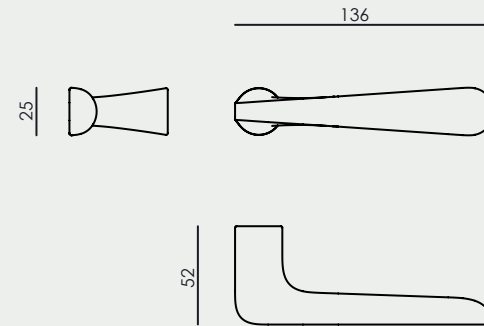

Quadro Spindle $\square 8$



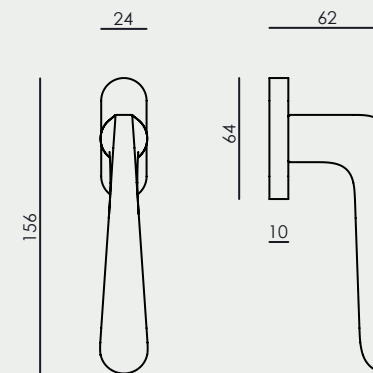

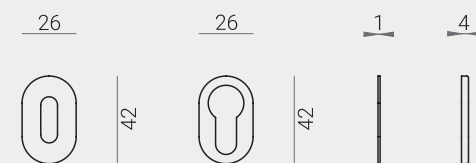

Finestra window



Bocchette Escutcheons



FINITURE FINISHES

-  **Cromo Satinato**
Satin Chrome
-  **Cromo Lucido**
Polished Chrome
-  **Nero Etna**
Etna Black
-  **Bianco Monviso**
Monviso White
-  **Bronzo Yester**
Yester Bronze
-  **Oro 24 Kt**
Gold 24 Kt

Wind

design Mattia Ferremi

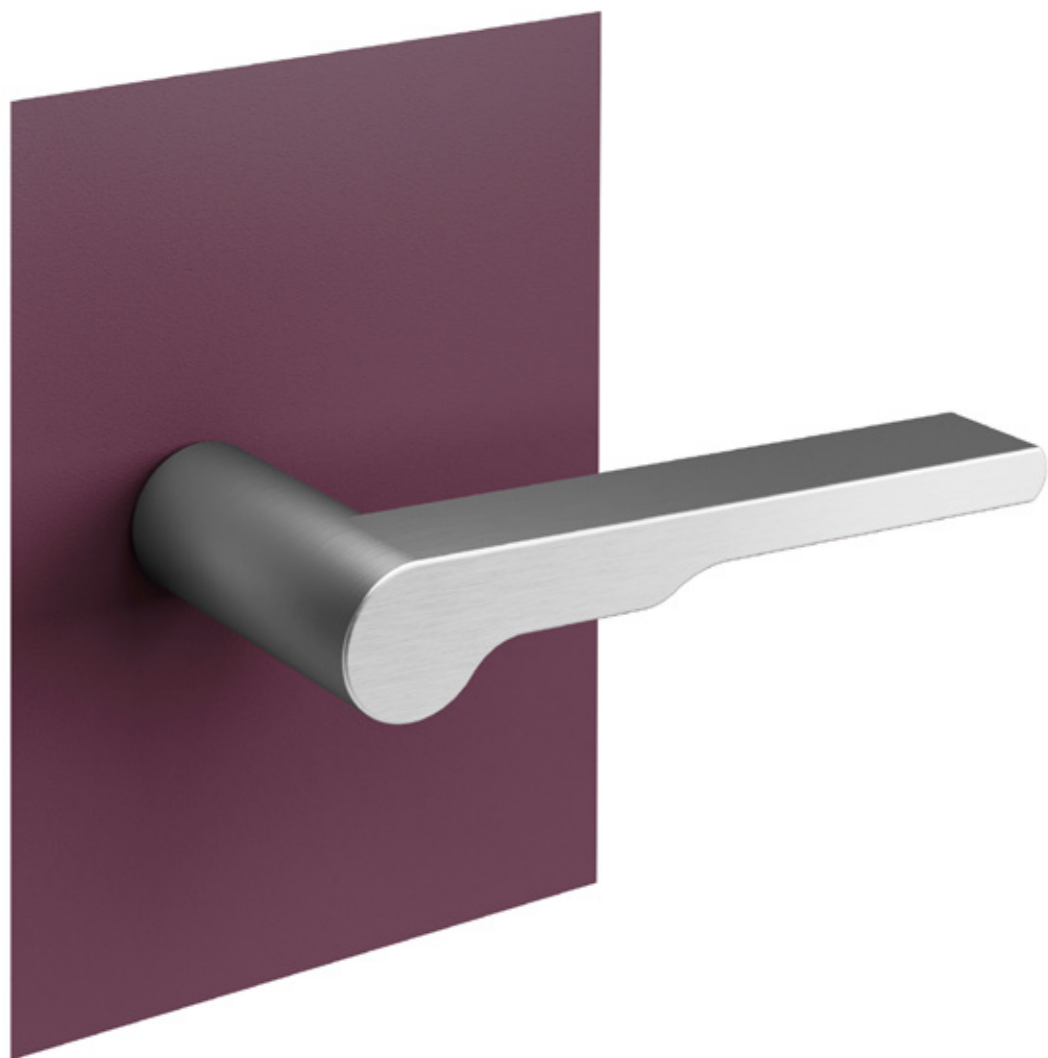

Cod. 127002
Materiale Zama / Material Zamak

Porta door

130 58

Quadro Spindle $\square 8$







Finestra window

24 68 10 64 150

Bocchette Escutcheons

26 26 1 4 42 42

FINITURE FINISHES

-  **Cromo Satinato**
Satin Chrome
-  **Cromo Lucido**
Polished Chrome
-  **Nero Etna**
Etna Black
-  **Bianco Monviso**
Monviso White
-  **Bronzo Yester**
Yester Bronze
-  **Oro 24 Kt**
Gold 24 Kt

Atlanta

design Nuda R&D

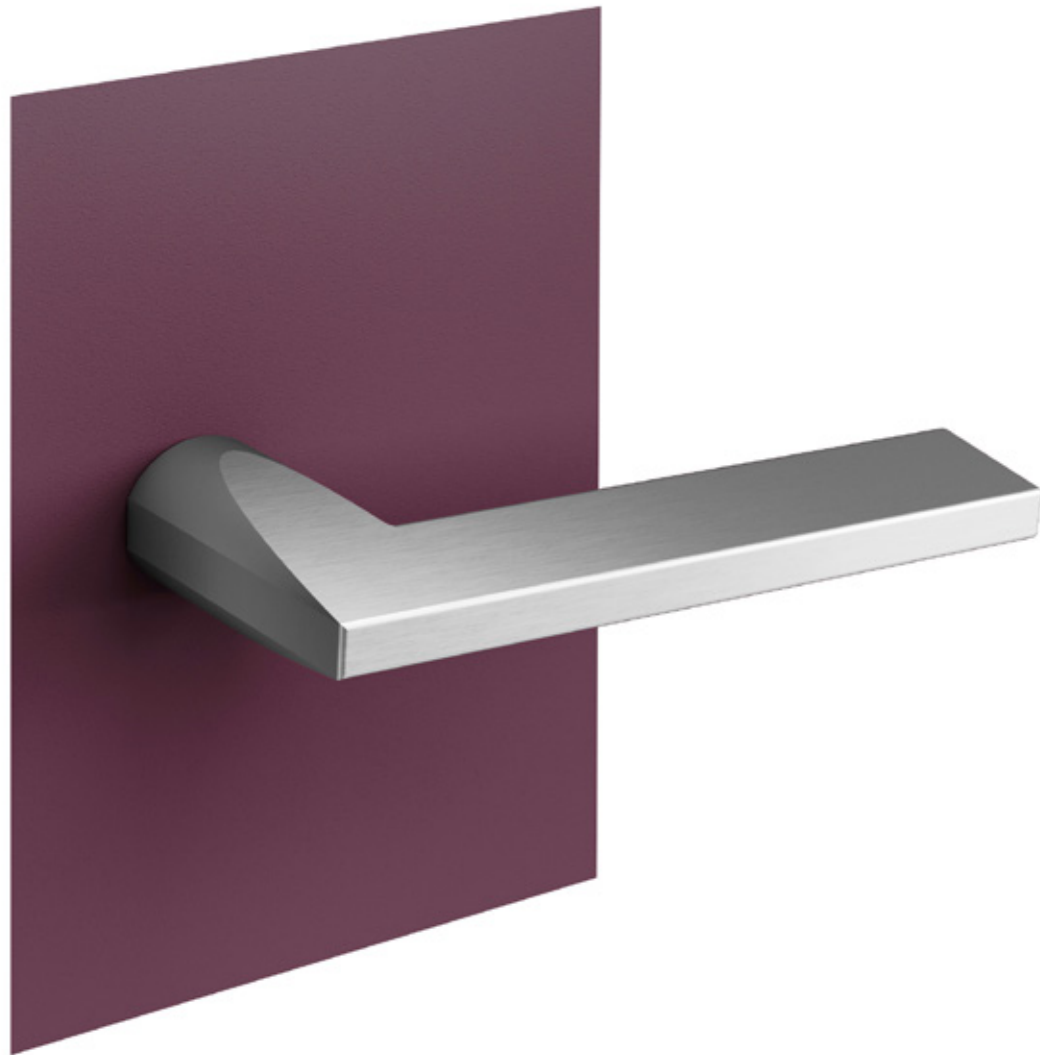

Cod. 127003
Materiale Zama / Material Zamak

Porta door

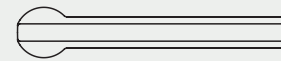

24

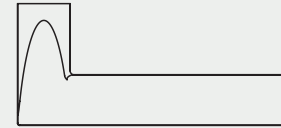

58

130

Quadro Spindle $\square 8$

Finestra window

24

68

10

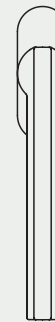

150

64

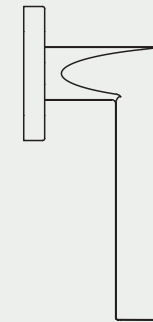

Bocchette Escutcheons

26

26

1

4



42



42



FINITURE FINISHES



Cromo Satinato
Satin Chrome



Cromo Lucido
Polished Chrome



Nero Etna
Etna Black



Bianco Monviso
Monviso White



Bronzo Yester
Yester Bronze



Oro 24 Kt
Gold 24 Kt

Lui

design Alessandro Stabile

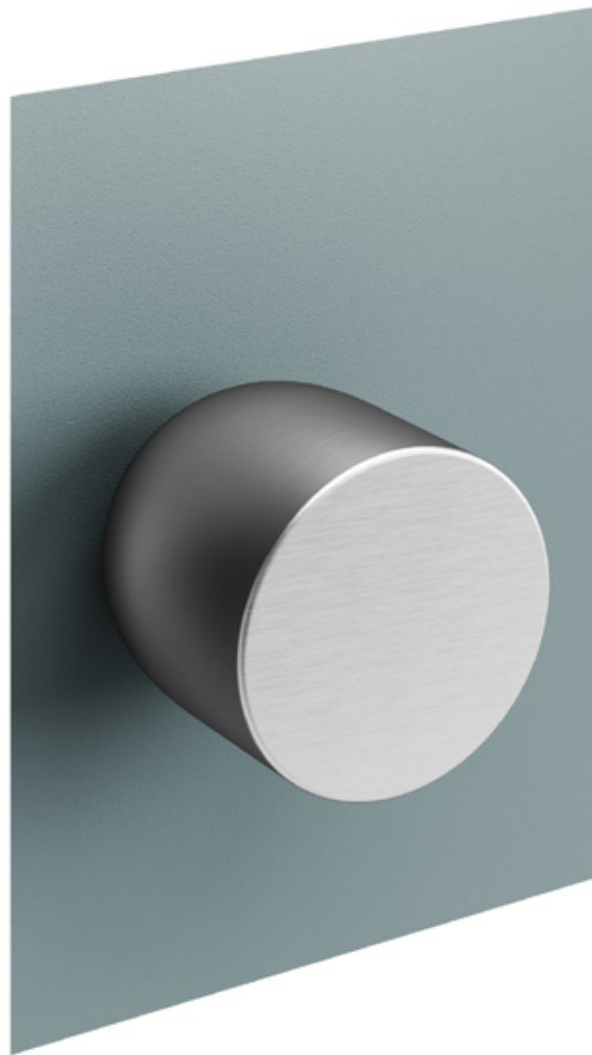

Cod. 127004

Set pomoli girevoli Turnable knob set

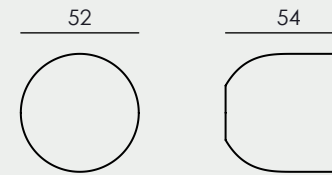

Quadro Spindle \square 8

Disponibili anche
Also available

Set pomolo fisso singolo Single fixed knob set

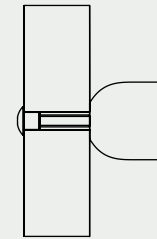

Set pomolo fisso doppio Double fixed knob set

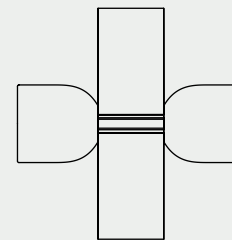



Bocchette Escutcheons



FINITURE FINISHES

Materiale Alluminio Material Aluminium

 **Grigio Milano**
Milano Grey

 **Nero Etna**
Etna Black

 **Bianco Monviso**
Monviso White

Materiale Ottone Material Brass

 **Cromo Satinato**
Satin Chrome

 **Bronzo Yester**
Yester Bronze

 **Ottone Lucido**
Polished Brass

Cham

design Nuda R&D



Set pomoli girevoli Turnable knob set

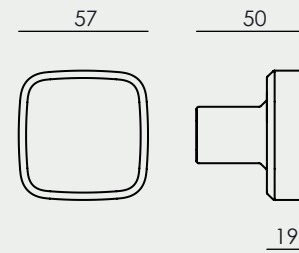

Quadro Spindle $\square 8$

Disponibili anche Also available

Set pomolo fisso singolo Single fixed knob set

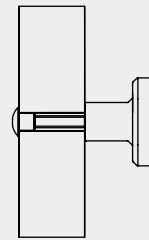

Set pomolo fisso doppio Double fixed knob set

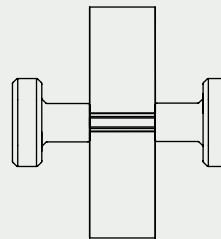



Bocchette Escutcheons



FINITURE FINISHES

Materiale Alluminio Material Aluminium

 **Grigio Milano**
Milano Grey

 **Nero Etna**
Etna Black

 **Bianco Monviso**
Monviso White

Materiale Ottone Material Brass

 **Cromo Satinato**
Satin Chrome

 **Bronzo Yester**
Yester Bronze

 **Ottone Lucido**
Polished Brass

Cod. 127008

Soap

design Nuda R&D

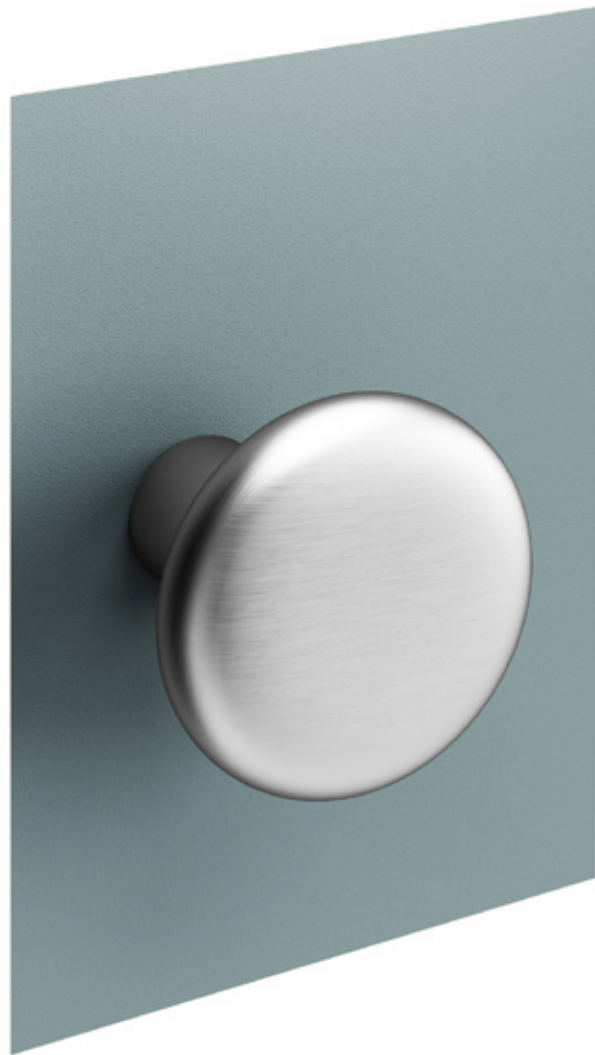

Cod. 127009

Set pomoli girevoli Turnable knob set

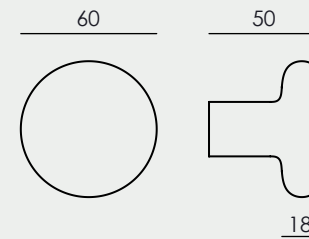

Quadro Spindle $\square 8$

Disponibili anche
Also available

Set pomolo fisso singolo Single fixed knob set

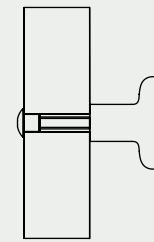

Set pomolo fisso doppio Double fixed knob set

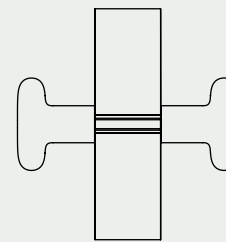

Bocchette Escutcheons



FINITURE FINISHES

Materiale Alluminio Material Aluminium

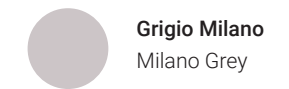

Grigio Milano
Milano Grey



Nero Etna
Etna Black



Bianco Monviso
Monviso White

Materiale Ottone Material Brass



Cromo Satinato
Satin Chrome



Bronzo Yester
Yester Bronze



Ottone Lucido
Polished Brass

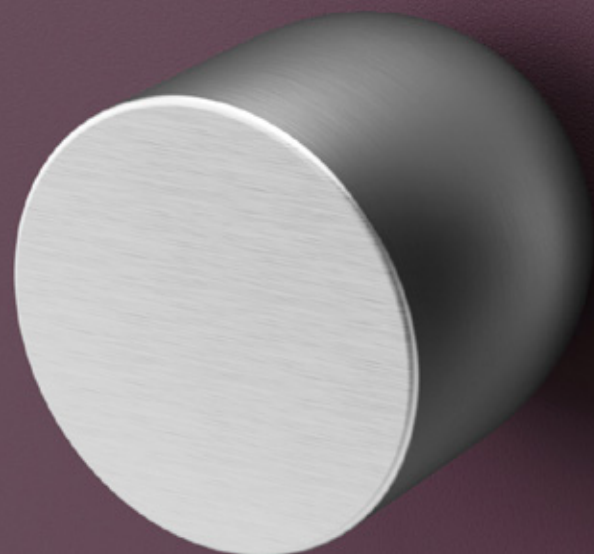

28	NOTTOLINO Privacy Set
30	FINESTRA Window
34	ACCESSORI Accessories
35	SERRATURE Locks
36	FORATURA PORTA Door Drilling
38	FINITURE Finishes
40	CONDIZIONI DI VENDITA Sales Terms

Nottolino Privacy set

Nuda offre dei nottolini dedicati da abbinare al design delle proprie maniglie per avere una continuità di immagine. Il nottolino diviene elemento tecnico, funzionale ed estetico al contempo.

Nuda offers privacy sets to be specifically matched to the design of the handles and have a continuity in terms of image. The privacy set becomes a technical, functional and aesthetic element at the same time.

Nottolino Punto può essere abbinato a tutte le maniglie della collezione Nuda.

Punto privacy set can be easily combined to every handle and knob of Nuda collection.

Spessore pannello 35-50 mm.
Altri spessori su richiesta.

Panel thickness 35-50 mm.
Other thicknesses available on demand.

Quadro Spindle $\square 6$

Diametro foro: 16 mm
Hole diameter: 16 mm

Cod.128015

Materiale Ottone

Materiale Brass

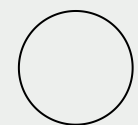
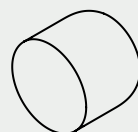

27

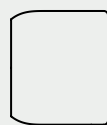

23



23

Finiture Finishes

Cromo satinato Satin chrome

Cromo lucido Polished chrome

Bianco Monviso Monviso white

Nero Etna Etna black

Bronzo yester Yester bronze

Grigio Milano Milano Grey



Nottolino per maniglia Pure e Wind
Privacy set for Pure and Wind handle

Spessore pannello tra 40 e 60 mm
Panel thickness 40-60 mm

Quadro Spindle \square 6

Cod. 128006

Diametro foro: 20 mm
Hole diameter: 20 mm

Materiale Zama
Materiale Zamak

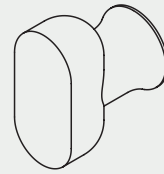

\varnothing 20

23

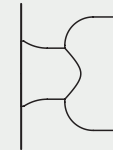
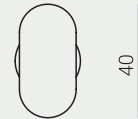

Nottolino per maniglia Atlanta
Privacy set for Atlanta handle

Spessore pannello tra 40 e 60 mm
Panel thickness 40-60 mm

Quadro Spindle \square 6

Cod. 128007

Diametro foro: 20 mm
Hole diameter: 20 mm

Materiale Zama
Materiale Zamak

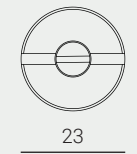

14

33

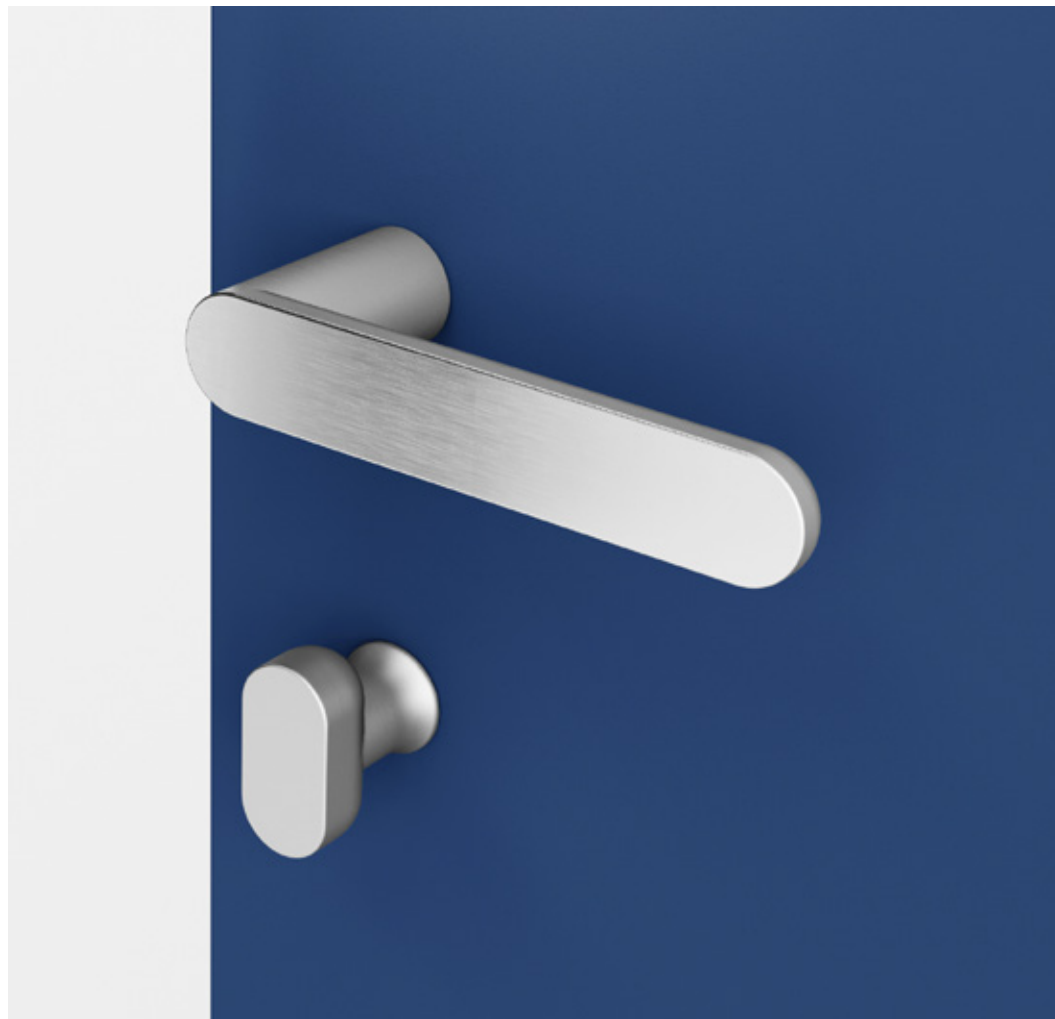
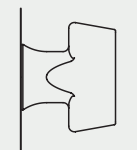
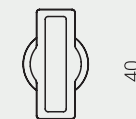



Finestra Window

Nuda offre una soluzione di estremo minimalismo anche per la finestra. La maniglia diviene così elemento di sintesi tra porta e finestra.

Nuda offers a solution of extreme minimalism also for the window. The handle becomes a perfect cohesion element between the door and the window.

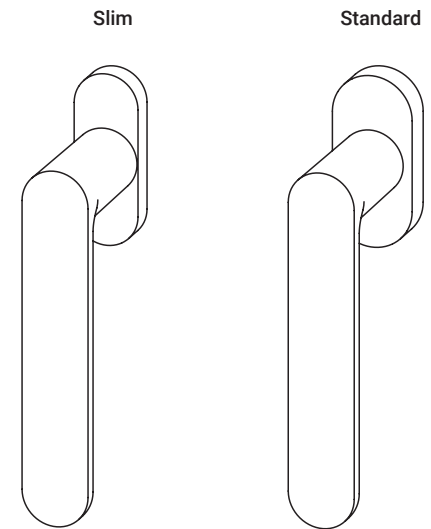

Materiale Zama Material Zamak

Finiture Finishes

Cromo satinato Satin chrome

Cromo lucido Polished chrome

Bianco Monviso Monviso white

Nero Etna Etna black

Bronzo yester Yester bronze

Slim 4 movimenti Slim 4 movements

24



152

Pure
Cod. 129001

Wind
Cod. 129002

Atlanta
Cod. 129003

Lieve
Cod. 129005

Baar
Cod. 129006

Pepe
Cod. 129007

Standard 4 movimenti Standard 4 movements

30

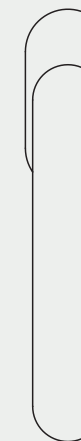

152

Pure
Cod. 129201

Wind
Cod. 129202

Atlanta
Cod. 129203

Lieve
Cod. 129205

Baar
Cod. 129206

Pepe
Cod. 129207

Accessori Accessories

1. Bocchette Escutcheons

A. Bocchetta Slim Slim escutcheon

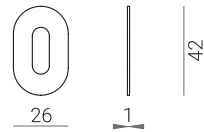

Foro Chiave
Key hole
Cod. 128002

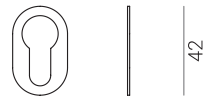

Foro Cilindro
Cylinder hole
Cod. 128005

B. Bocchette Standard Standard escutcheon

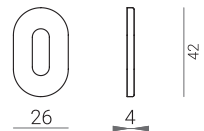

Foro Chiave
Key hole
Cod. 128001



Foro Cilindro
Cylinder hole
Cod. 128004

C. Rondella diametro 30 mm 30 mm diameter washer

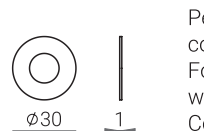

Per pannelli preforati
con diametro fino a 25 mm
For predrilled panels
with a diameter up to 25 mm
Cod. 128009

D. Bocchetta slim diametro 30 mm per foro chiave Slim key hole escutcheon diameter 30 mm



Da abbinare a rondella
diametro 30 mm - Art 128009
To be matched with 30 mm
diameter washer - Art 128009
Cod. 128010

E. Rondella diametro 24 mm 24 mm diameter washer



Per pannelli preforati
con diametro fino a 20 mm
For predrilled panels
with a diameter up to 20 mm
Cod. 128008

2. Quadri Spindles

Le maniglie della collezione Nuda vengono fornite con un quadro con fissaggio a due grani per porte di spessore compreso tra i 40 e 60 mm. Su richiesta è possibile realizzare quadri di lunghezza differente.

Per il mondo dell'industria, è possibile richiedere un quadro premontato di lunghezza desiderata con fissaggio a un solo grano.

Nuda handles come as standard with a spindle with 2 fixing grains for 40-60 mm thickness doors. On demand, it is also possible to provide spindles of different lengths.

For the industry sector, Nuda handles can be provided with preassembled spindles of desired length with a single fixing grain.

Serrature Locks

Serrature magnetiche Magnetic locks Cod. 180

Serrature meccaniche Mechanical locks Cod. 183

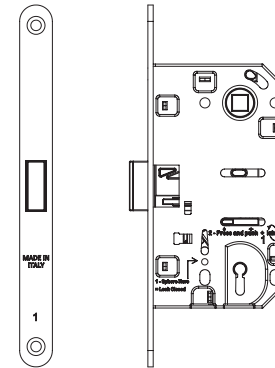

Foro chiave
Key hole

Cod. 004

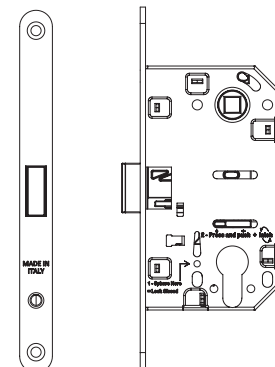

Foro cilindro
Cylinder hole

Cod. 005

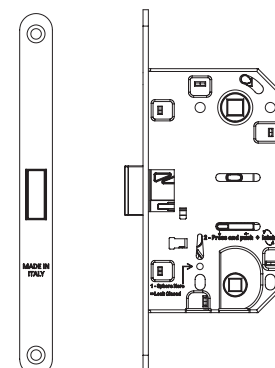

Foro nottolino
Privacy set hole

Cod. 006

Incontri Striking plates

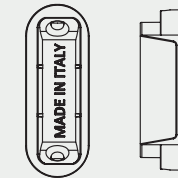

Incontro per serratura magnetica
Striking plate for magnetic lock
Cod. 181001

Incontro per serratura meccanica
Striking plate for mechanical lock
Cod. 184005

Materiale Abs Material Abs

Finiture Finishes

Cromo satinato Satin chrome

Bianco Monviso Monviso white

Nero Etna Etna black

Bronzo yester Yester bronze

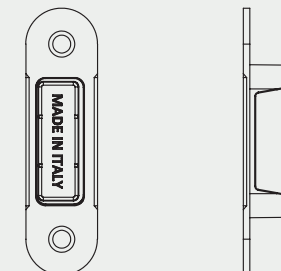

Incontro con piastrina per serratura magnetica
Striking plate with platelet for magnetic lock
Cod. 181003

Incontro con piastrina per serratura meccanica
Striking plate with platelet for mechanical lock
Cod. 184004

Materiale Abs e metallo Material Abs and metal

Finiture Finishes

Cromo satinato Satin chrome

Cromo lucido Polished chrome

Bianco Monviso Monviso white

Nero Etna Etna black

Bronzo yester Yester bronze

Foratura porta Door drilling

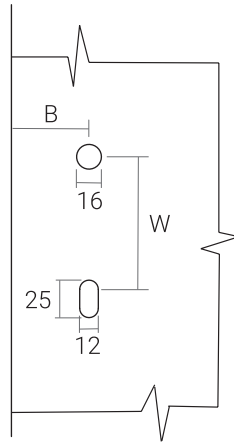
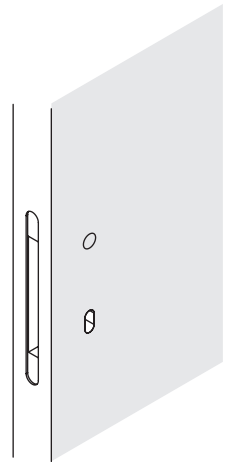

**Maniglia con bocchetta foro chiave standard e slim.
Set pomoli girevoli con bocchetta foro chiave standard o slim.**

Handle with standard or slim key hole escutcheon.
Turnable knob set with standard or slim key hole escutcheon.

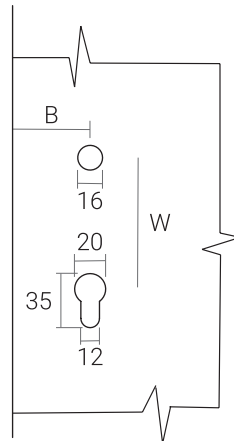
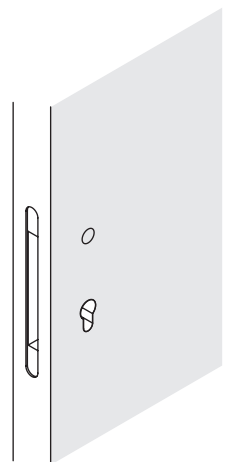

**Maniglia con bocchetta foro cilindro standard e slim.
Set pomoli girevoli con bocchetta foro cilindro standard o slim.**

Handle with standard or slim cylinder hole escutcheon.
Turnable knob set with standard or slim cylinder hole escutcheon.

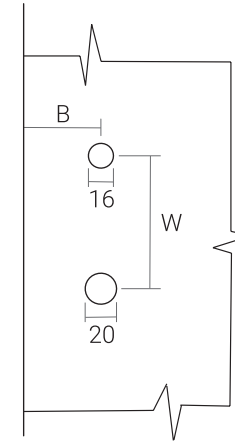
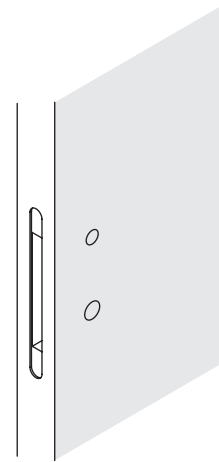

**Maniglia con nottolino mod. Pure/Wind e Atlanta
Set pomoli girevoli con nottolino mod. Pure/Wind e Atlanta**

Handle with privacy set mod. Pure/Wind and Atlanta
Turnable knob set with privacy set mod. Pure/Wind and Atlanta

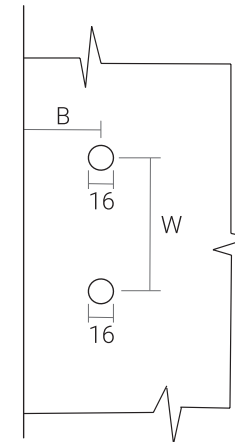
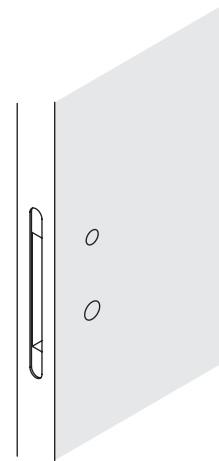

**Maniglia con nottolino mod. Punto
Set pomoli girevoli con nottolino mod. Punto**

Handle with privacy set mod. Punto
Turnable knob set with privacy set mod. Punto

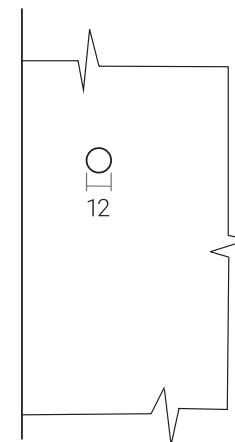
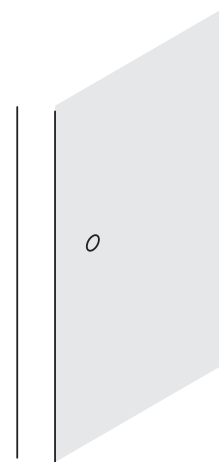

Pomolo fisso singolo/ doppio

Fixed single/ double knob set

Finiture Finishes

Cod.14
Cromo satinato
Satin Chrome



Cod.18
Nero Etna
Etna Black



Cod.49
Bianco Monviso
Monviso White



Cod.39
Cromo lucido
Polished Chrome



Cod.21
Bronzo Yester
Yester Bronze



Cod.80
Grigio Milano con trattamento antibatterico
Milano Grey with antibacterial treatment

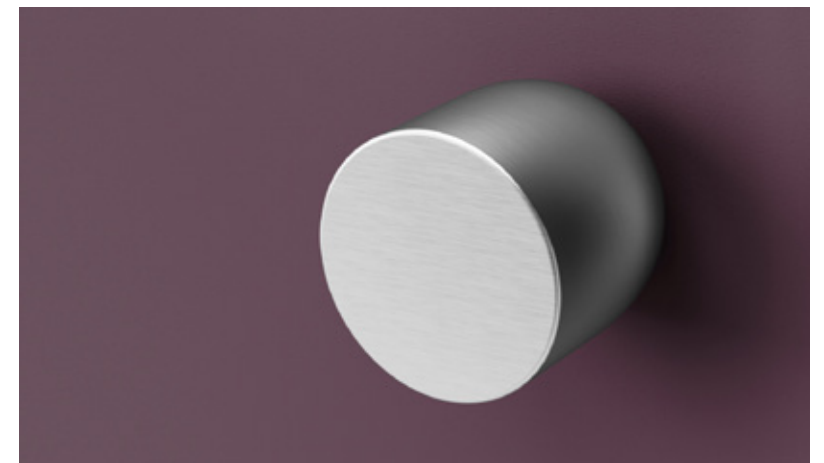

*Finiture speciali su richiesta
Special finishes on demand

CONDIZIONI GENERALI DI VENDITA

MODELLI, DIMENSIONI, PESI

Verum Italy si riserva, in qualunque momento e senza preavviso, di modificare e/o sopprimere gli articoli del presente catalogo. Dati, misure o schemi su questo catalogo hanno solamente carattere informativo, non sono vincolanti e possono essere soggetti a variazioni.

ORDINI

Verranno accettati solo ordini per iscritto; ordini pervenuti telefonicamente o verbalmente non saranno ritenuti validi. Con la trasmissione dell'ordine il cliente accetta tutte le condizioni elencate di seguito. L'ordine è vincolante per il cliente, mentre impegna Verum Italy srl solo dopo espressa accettazione. Non possono essere effettuati annullamenti senza l'accordo scritto di Verum Italy, che si riserva comunque di applicare oneri e spese che ne derivino.

TERMINI DI CONSEGNA

I tempi di consegna dell'ordine decorrono dalla data della nostra conferma salvo diversa stipulazione e non potranno in nessun luogo dare luogo ad indennizzo/risarcimento da parte di Verum Italy. I termini di consegna indicati nell'ordine sono da intendersi puramente indicativi e non vincolanti per Verum Italy, che non sarà responsabile di eventuali ritardi. In particolare non è responsabile per ritardata o omessa consegna, totale o parziale, imputabile a cause di forza maggiore, o ad eventi che siano fuori dal suo controllo, quali, in via esemplificativa, scioperi aziendali e di trasporto, mancanza di energia elettrica, mancata o ritardata ricezione di materie prime, ecc. Verum Italy si riserva il diritto di evadere l'ordine anche con spedizioni parziali.

DATI IDENTIFICATIVI DEL CLIENTE

Il cliente è responsabile della comunicazione dei propri dati fiscali forniti in base alla legislazione vigente (Ditta, Ragione sociale, Sede, Partita IVA). I dati del cliente saranno custoditi ed elaborati per adempimenti degli obblighi di Legge. Ogni altro utilizzo dovrà essere espressamente autorizzato dal cliente.

SPEDIZIONI

La merce viaggia a rischio e pericolo del committente franco stabilimento Verum Italy o Grip Italia, che declina comunque ogni responsabilità per ritardi o rotture verificatesi durante il trasporto. Spetta al committente verificare la merce in arrivo e contestare eventuali danni direttamente al trasportatore, anche se questi è stato scelto da Verum Italy, entro 8 giorni dal ricevimento della stessa mediante raccomandata A.R. Si accettano eventuali reclami sulla quantità di pezzi ricevuta al massimo entro 8 giorni dalla data di consegna.

PAGAMENTO

I pagamenti devono essere effettuati direttamente a Verum Italy nei termini pattuiti. Trascorsi i termini Verum

Italy provvederà senza alcun preavviso all'addebito degli interessi di mora stabiliti per Legge, che decorreranno dal giorno immediatamente successivo alla scadenza del debito. Il mancato rispetto dei pagamenti pattuiti, comunicati per iscritto nelle conferme d'ordine, può comportare, a discrezione dell'azienda, il blocco degli ordini in corso fino a pagamento avvenuto e la sospensione delle ulteriori forniture anche se già accettate. I pagamenti dei prodotti già consegnati non saranno subordinati al completamento dell'ordine. Nessun pagamento potrà essere differito nel caso di contestazioni salvo accordi diversi. Fino al momento in cui Verum Italy non abbia ricevuto il pagamento del valore complessivo dei prodotti, gli stessi rimarranno di esclusiva proprietà di Verum Italy.

RESPONSABILITÀ

Non si accettano merci di ritorno se non rese in Porto Franco e preventivamente autorizzate da Verum Italy. Solo il materiale riscontrato difettoso da Verum Italy sarà sostituito gratuitamente senza nessun altro indennizzo per danni, spese o riparazioni. Verum Italy non si assume alcuna responsabilità e alcuna garanzia è prevista per difetti e danni derivanti da installazione impropria o cattivo uso. È vietato agli acquirenti effettuare qualsiasi lavorazione che modifichi le caratteristiche originarie dei prodotti Verum Italy.

CONTROVERSIE

Le forniture sono soggette alla Legge italiana. NUDA utilizza un sistema brevettato da Grip Italia Srl e ne è vietata la riproduzione o la copia non autorizzata. I trasgressori saranno puniti a norma di legge. Per qualunque controversia è riconosciuta la sola ed esclusiva competenza del Foro di Monza, Italia.

TERMINI DI GARANZIA

Si certifica che le maniglie della collezione Nuda sono interamente prodotte in Italia nelle nostre aziende. Ogni articolo, stampato o fuso e lavorato a mano è unico ed irripetibile e le piccole differenze cromatiche, che possono riscontrarsi, rappresentano la garanzia più certa dell'artigianalità del prodotto. Eventuali imperfezioni e/o differenze nella forma, nelle finiture e nei materiali sono da attribuire alla tecnologia e/o alle operazioni manuali necessarie alla lavorazione del prodotto. L'inosservanza delle istruzioni di montaggio e/o una non cura nell'utilizzo possono causare il mal funzionamento del sistema, per i quali si declina ogni responsabilità.

CONSIGLI PER LA PULIZIA, LA CURA E LA MANUTENZIONE DEL PRODOTTO

Si consiglia di pulire le maniglie della collezione Nuda utilizzando solamente un panno asciutto o leggermente inumidito con acqua. Non utilizzare assolutamente alcun detergente chimico per non alterare l'efficacia del trattamento superficiale.

GENERAL SALES TERMS AND CONDITIONS

MODELS, DIMENSIONS AND WEIGHTS

Verum Italy Srl reserves the right, at any time, to change and/or to cancel the items of this catalogue. Information, size or drawings in this catalogue are only for information and are not binding.

ORDERS

Orders are accepted only in written form; orders or modifications communicated verbally and/or by phone will not be valid. Customers accept and are aware that their order is subject to the following general sale terms and conditions. Verum Italy Srl is not legally bound by an order until we have confirmed it in written form but the Customer is bound when he/she accepts it. No cancellation of the order is valid without written agreement from Verum Italy Srl, which reserves the right to apply charges.

DELIVERY TERMS

Delivery time starts from the order confirmation date, unless otherwise agreed, Verum Italy Srl will not recognize any indemnity or compensation. The order delivery terms are purely indicative and not binding for Verum Italy Srl, which is not responsible for any delay. Verum Italy Srl is not liable for delayed or skipped delivery in its totality or partiality, due to acts of God or other event out of its control, like for example labour or freight strikes, lack of electric energy, missed or delayed raw material receipt and so on. Verum Italy Srl reserves the right to dispatch orders even with partial shipment.

CUSTOMER INFORMATION

The Customer is responsible for all the identification information data requested by the legislation in effect (Company name, legal name, Address, VAT, etc.). All Customer's data will be kept and used in full compliance with the Italian Law. All other use must be specifically allowed by the Customer.

DELIVERIES

Ordered goods will be at the Customer's risk from the moment of delivery so Verum Italy Srl declines any responsibility for delays or damage caused during the shipment. The Customer is responsible for checking the delivered goods and reporting possible damage to the forwarder, even if chosen by Verum Italy Srl, within 8 (eight) days from receipt by certified mail. The Customer is also responsible for checking the quantity of the delivered goods; claims about quantity will only be accepted within 8 (eight) days from receipt.

PAYMENTS

Payments shall be made directly to Verum Italy Srl in the manner and at the time agreed by the parties. In the event of failure to make the payment at the due date, the Customer will, with effect from the invoice date, be charged of interests and penalties. If the Customer is in default, Verum Italy Srl shall have the right to defer shipment or any future order intake or delivery until such

default is remedied or said credit re-established to our satisfaction. No claim shall enable the customer to suspend payments. The payment of products already delivered shall not oblige Verum Italy Srl to complete the order. In case of disagreements payments cannot be deferred, unless otherwise agreed. Until the receipt of payment for the total value of the goods ordered, Verum Italy Srl will be and remain the sole and only proprietor of the goods.

RESPONSIBILITY

Verum Italy Srl does not accept return of goods without prior approval, in all cases costs for goods returns must be borne by the Customer. Only faulty goods found by Verum Italy Srl will be replaced free of charge without any other indemnity or refund for damage or repairs. Verum Italy Srl is not responsible for any faulty goods which have been manipulated in a bad way. Any damage caused by improper installation or use is not covered by any guarantee. Customers are not authorized to rework Verum Italy Srl products.

CONTROVERSY

Orders are governed by the Italian Law. If the parties cannot reach amicable settlements, disputes shall be referred uniquely to the competent civil court in Monza. NUDA use a patented system of Grip Italia Srl and unauthorized copying or copying is prohibited. Violators will be punished according to the Italian law.

WARRANTY

We certify with our complete and utmost corporate integrity that the handles of Nuda collection are produced solely within our Italian manufacturing facilities. Each piece of hardware, forged or cast is hand-crafted to perfect the uniqueness in design and finish. The guarantee of originality is due to the fact that the finish of each product is slightly different than the previous item. Any imperfections or differences in form, finishes and materials are to be attributed to the technology or manual operations necessary for processing the product. Failure to comply with the instructions and / or a lack of care in use may cause the system to malfunction, for which the manufacturer declines all responsibility.

CLEANING SUGGESTIONS

In order to maintain the quality of the protective treatment and uniqueness of all finishes do not attempt to clean with detergents and/or chemicals. Hence, simply use a lightly water moistened cloth to clean the items.

La collezione Nuda è interamente ideata, sviluppata e prodotta in Italia. Ogni minimo dettaglio viene attentamente curato per offrire la migliore qualità del made in Italy unito ad un'innovazione tecnologica garantita da brevetti internazionali.

Verum Italy è un acceleratore di idee, un'azienda in cui innovazione e ricerca si concretizzano per creare prodotti unici: soluzioni intelligenti per gli spazi abitativi. Verum Italy opera nel mondo del design per offrire al mercato prodotti inediti e rivoluzionari garantendo estetica e funzionalità.

Verum Italy, fondata da Umberto Vergani nel 2012, opera ora in numerosi Paesi del mondo esportando la qualità e l'intelligenza italiana.

GRIP Italia è un'azienda dal forte contenuto tecnologico e di ricerca che da sempre produce e trasforma prodotti in metallo nell'ambito della componentistica.

L'intero processo produttivo avviene nel rispetto delle norme ambientali, limitando gli scarti e garantendone il riciclo.

Nuda collection is completely conceived, designed and produced in Italy. Every single detail is taken care of to offer the best quality of Made in Italy together with technological innovations protected by international patents.

Verum Italy is an ideas accelerator, a company where innovation and research meet to create unique products: smart solutions for living spaces. Verum Italy operates in the design field to offer to the market original and revolutionary products characterised by design and functionality.

Umberto Vergani established Verum Italy in 2012 and since then has operated worldwide exporting Italian quality and know-how.

GRIP Italia is a company with a strong technological and research content that has always produced and transformed metal products in the hardware sector.

The whole production process complies with environmental standards, generating little waste that can be completely recyclable.

Verum Italy

**Strada Statale Briantea, 40
23892 Bulciago LC
Italia**

**+39 031 355 9009
info@verumitaly.it**

VERUM
ITALY