

STORM SYSTEM®

The Storm Medium Concrete Halo-X is part of the STORM SYSTEM® MEDIUM collection. A collection that includes a wide range of special designed products. The STORM SYSTEM® collection is carefully designed to flush the surface of any ceiling or wall, and all products will appear with an absolute minimum of tolerance and visibility.

Storm Medium Concrete Halo-X BMR is a combination of a Storm Medium Back-Mounted ring and a HaloX® 100 front ring. The installation ring is compatible with all HaloX® 100 units, making it possible to integrate the STORM SYSTEM® Medium in concrete ceilings.

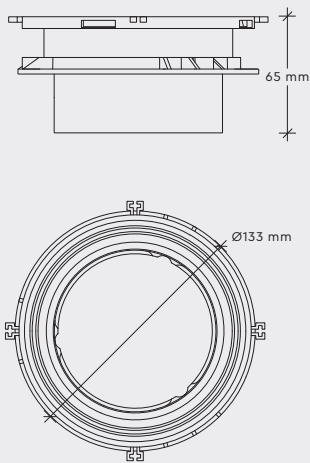

Watch installation video

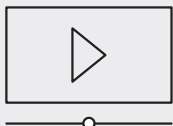

STORM MEDIUM CONCRETE HALO-X BMR

DATA

Collection	STORM SYSTEM®
Product	Storm Medium Concrete Halo-X BMR
Article no.	1A01.0055.xx

SPECIFICATIONS

Weight	111 g
Material	ABS
Fixture finish	For xx-codes review STORM SYSTEM® – COLOUR CODES ➤

ADDITIONAL REQUIREMENTS

Fixture	Product from the STORM SYSTEM® MEDIUM collection
HaloX® 100 box (not included - available in local stores)	Find your suitable HaloX® 100 box here ➤

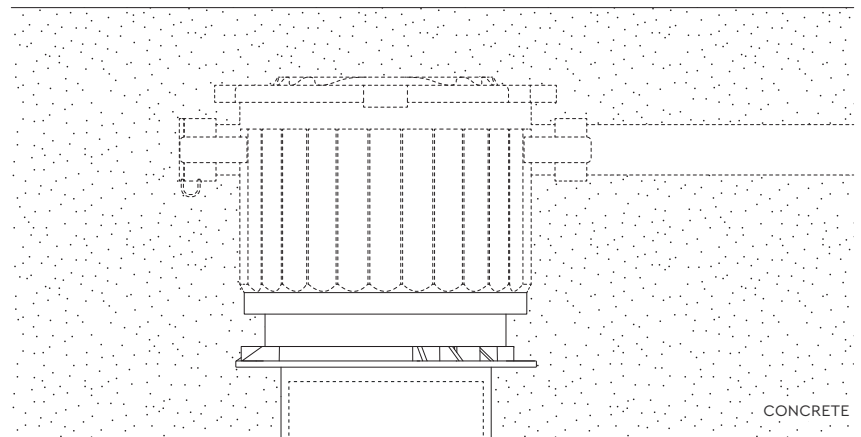

OPTIONAL ACCESSORY

Storm Medium Recess Plug – custom accessory

If applied, the Storm Medium Recess Plug replaces the Storm S Base. Before installation, remove the spring from the Storm S Base, and add it to the Storm Medium Recess plug, then follow the assembly instructions.

The custom recess plug requires concrete form oil in order to optimize release of the form, this process must be clarified on site. It is crucial for the final result, that the assembly instructions have been followed.

It is recommended that a test cast is made, to ensure that all parties agree upon the final result.



IMPORTANT INFORMATION

Installation and mounting must be performed by skilled personnel only, and instructions must be followed.

CLEANING AND MAINTENANCE:

Use a soft moist cloth for cleaning. No further maintenance is required.

WARRANTY:

If the product is defect, please contact your supplier immediately. Please note that warranty will not apply in case of wrongful use or if unskilled personnel attempts to repair.

COMPONENTS

- Storm Medium Concrete Halo-X BMR
- Storm Medium S Base

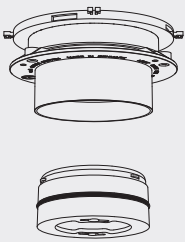

STORM MEDIUM CONCRETE HALO-X BMR

ASSEMBLY INSTRUCTION PAGE 1 OF 2

STEP 1

Mark out on the underlay, where you want your installations to be.

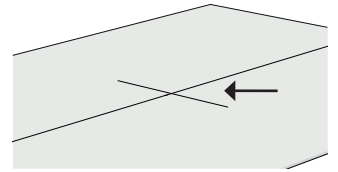

STEP 2

Place the Storm S Base over the mark, and mark out the position for the screws. Then fasten the screws to the underlay

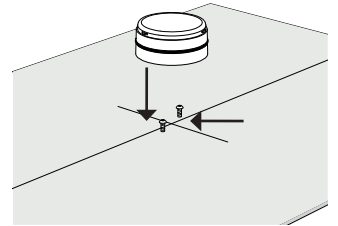

STEP 3

Place the Storm S Base over the screws, rotate slightly and fasten the screws.

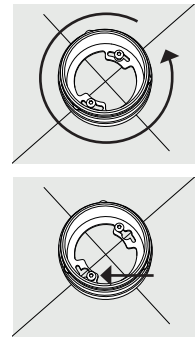

STEP 4

Place the reinforcement mesh (if using this) over the Storm S Base.

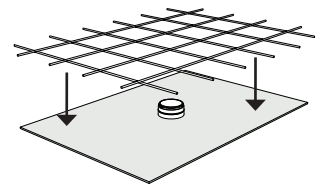

STEP 5

Click your chosen HaloX® 100 unit onto the Storm Medium Concrete Halo-X BMR.

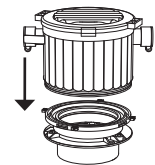

STEP 6

Mount the Storm Concrete Halo-X BMR onto the Storm S Base.

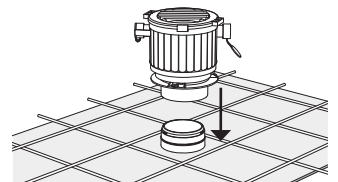

IMPORTANT INFORMATION

Installation and mounting must be performed by skilled personnel only, and instructions must be followed.

CLEANING AND MAINTENANCE:

Use a soft moist cloth for cleaning. No further maintenance is required.

WARRANTY:

If the product is defect, please contact your supplier immediately. Please note that warranty will not apply in case of wrongful use or if unskilled personnel attempts to repair.

STORM MEDIUM CONCRETE HALO-X BMR

ASSEMBLY INSTRUCTION PAGE 2 OF 2

STEP 7

Make sure that the two components are completely flush with the underlay.

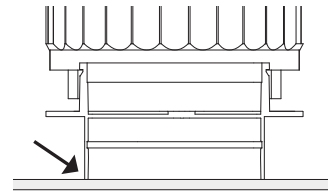

STEP 8

Fasten the conduit to the outlet/outlets you are going to use.

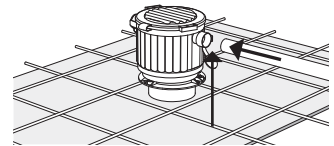

STEP 8.1

Fastening methods for the conduit depending on type.

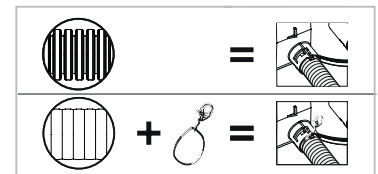

STEP 9

Anchor the Storm Concrete Halo-X BMR to the reinforcement mesh.

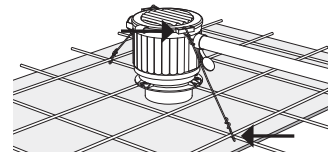

STEP 10

Make sure that the concrete completely surrounds the Storm installation ring.

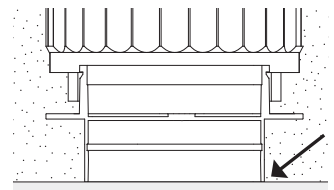

STEP 11

When the concrete is dry pull down the underlay.

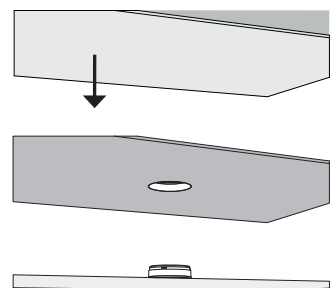

STEP 12

Feed the supply wire through the conduit and out through the Storm Concrete Halo-X BMR

