







LAURENT 03

The Laurent Collection distills the milk globe to its essential relationship between circle and sphere. A series of thin forms compliment the Laurent globes—forms that carve through space, moving between line, surface, and volume. These forms combine in endless patterns, making it possible for an installation of Laurent lamps to inhabit any space with subtlety and quiet strength.

- type:** suspension
- construction:** polished brass, powder coated aluminium or nickel plated steel frame
handblown opaline glass globe
powder coated aluminium or brass hardware
polyester cord
- specifications:** source: LED lamp provided (G9 base)
power consumption: 2x 4,5W
lumen output: 638lm
colour temperature: 2700K included
* 3000K available upon request
colour rendering index: 80 CRI standard
* ≥ 90 CRI upon request
expected lifetime: 25 000h
- control:** refer to our recommended list of dimmer models
- cord length:** 84" / 213 cm (minimum 30" / 76 cm for angled wires)
- weight:** parrallel- brass/nickel plated: 12.1 lb / 5.5 kg
aluminium: 9.1 lb / 4.1 kg
angled- brass/nickel plated: 10.3 lb / 4.7 kg
aluminium: 7.3 lb / 3.3 kg
- certifications:**     IP20
- warranty:** 2 years

parallel wires

parallel wires with offset connection

angled wires

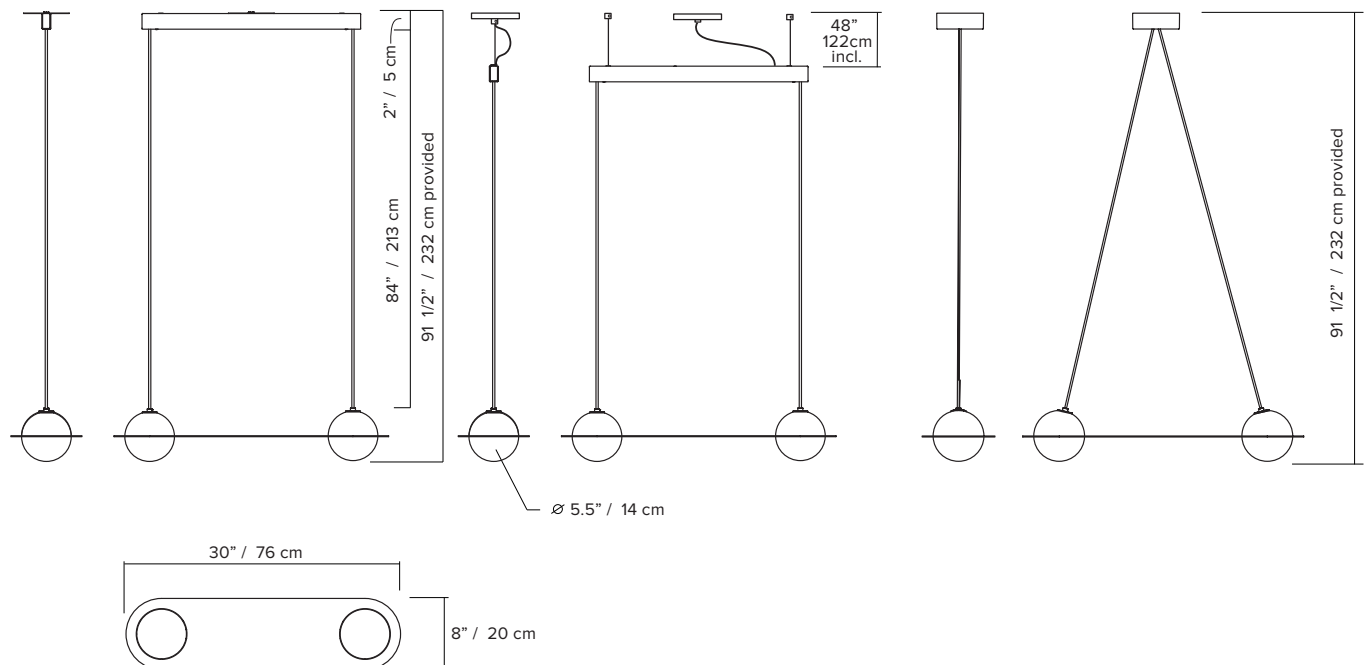

*dimensions are approximate and may vary slightly

ORDER GUIDE: SKU

| COLLECTION | MODEL | MOUNTING TYPE | FRAME | CORD | CANOPY | MOUNTING TYPE FINISH* |
|-------------------------------------|-----------|---|-------------------------|--------------------|--------------------|-----------------------|
| LRT | Laurent | 03 | AW angled wires | BK black | BK black | BK black |
| | | PWOS parallel wires -offset mount | BR brass | BR brass | BE blue | BE blue |
| | | PWCM -parallel wires -ceiling mount | BE blue | BE blue | BU burgundy | BU burgundy |
| | | | BU burgundy | BU burgundy | WH white | WH white |
| | | | CH nickel plated | BG beige | BG beige | BG beige |
| LRT | 03 | PWOS | BK | BK | BK | BK |
| = LRT03PWOSBKBKBK example | | | | | | |

FRAME



textured black



brass



textured blue



textured burgundy



nickel plated

CORD SYSTEM FINISH globe holders & cords



textured black



brass



textured blue



textured burgundy



textured beige

CANOPY

*black, white or same colour as cord system



textured black



textured white



textured blue



textured burgundy



textured beige

MOUNTING TYPE SYSTEM

ceiling disc or offset canopy with anchors

*black, white or same colour as canopy



textured black



textured white



textured blue



textured burgundy



textured beige

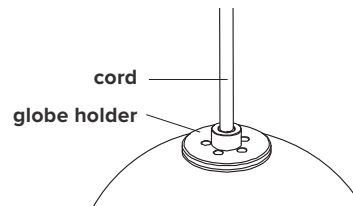
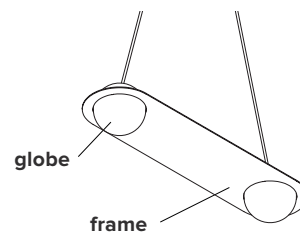

parallel wires
PW

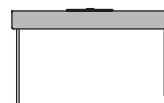

angled wires
AW



parallel wires
-ceiling mount
PWCM

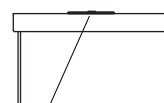

parallel wires
-offset mount
PWOS

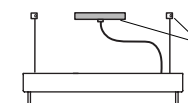

offset canopy
with anchors

ceiling disc

DIMMER SPECIFICATIONS

DIMMER LIST COMPATIBILITY FOR G9 LED BULBS – 120V

The dimming technology offering the best results is ELV (electronic low voltage) dimmers with reverse phase or trailing edge control.

| DIMMER BRAND | MODEL NUMBER | MIN LEVEL | MAX LEVEL | FLICKERING | OVERALL QUOTE |
|------------------|----------------|-----------|-----------|------------|---------------|
| LUTRON - MAESTRO | MAELV-600 | 0% | 100% | 0%-10% | good |
| LUTRON - SKYLARK | SELV-300P | 0% | 100% | no | very good |
| LUTRON - SKYLARK | SELV-303P | 0% | 100% | no | very good |
| LUTRON - SKYLARK | CTELV-303P | 0% | 100% | no | very good |
| LUTRON - DIVA | DVELV-300P | 0% | 100% | no | very good |
| LEGRAND - ADORNE | TRUE UNIVERSAL | 30% | 100% | no | good |

DIMMER LIST COMPATIBILITY FOR G9 LED BULBS – 230V

| DIMMER BRAND | MODEL NUMBER | MIN LEVEL | MAX LEVEL | FLICKERING | OVERALL QUOTE |
|-----------------|--------------|-----------|-----------|------------|---------------|
| VARILIGHT | V-PRO | 2% | 100% | no | very good |
| LEGRAND - NILOÉ | 3 996 35 | 15% | 87% | no | good |
| NIKO | 310-0280X | 5% | 94% | no | very good |
| NIKO | 310-0190X | 1% | 100% | no | very good |

*Other dimmers can yield good results and we recommend conducting your own test before final installation.

EU ENERGY LABEL

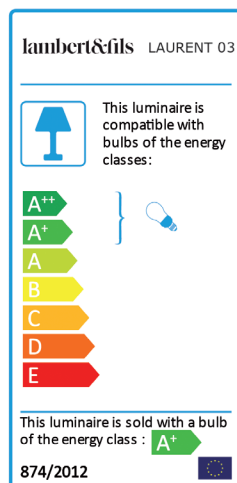

NOTES:

- must be installed by an electrician
- ceiling anchors not meant for slanted ceilings (available upon request)
- not protected against liquids (refer to IP20)
- additional charges for modifications or for special orders
- please refer to maintenance sheet on website for cleaning instructions