

LAURENT 10

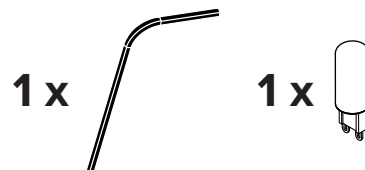

- To be installed by an electrician to an electrical box
- Use appropriate screws and anchors where necessary
- Wear enclosed gloves when handling lamp
- Handle materials with care. Please consult lamp maintenance sheet on our web site
- Should be used exclusively as a lamp and not as a shelving, display or hanging unit

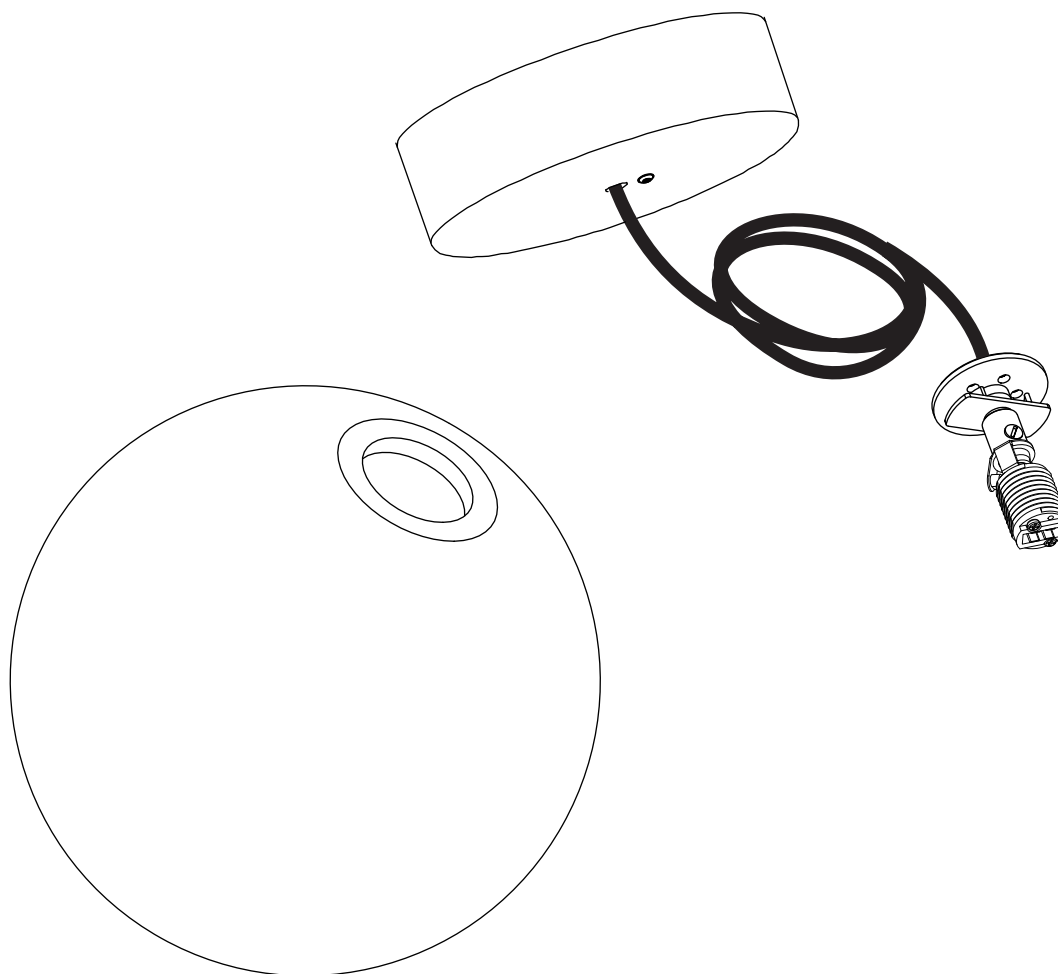

1

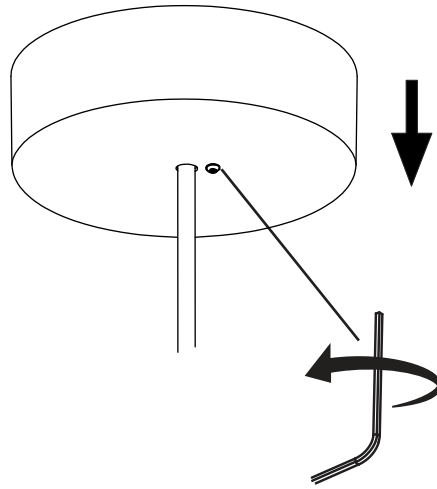

2

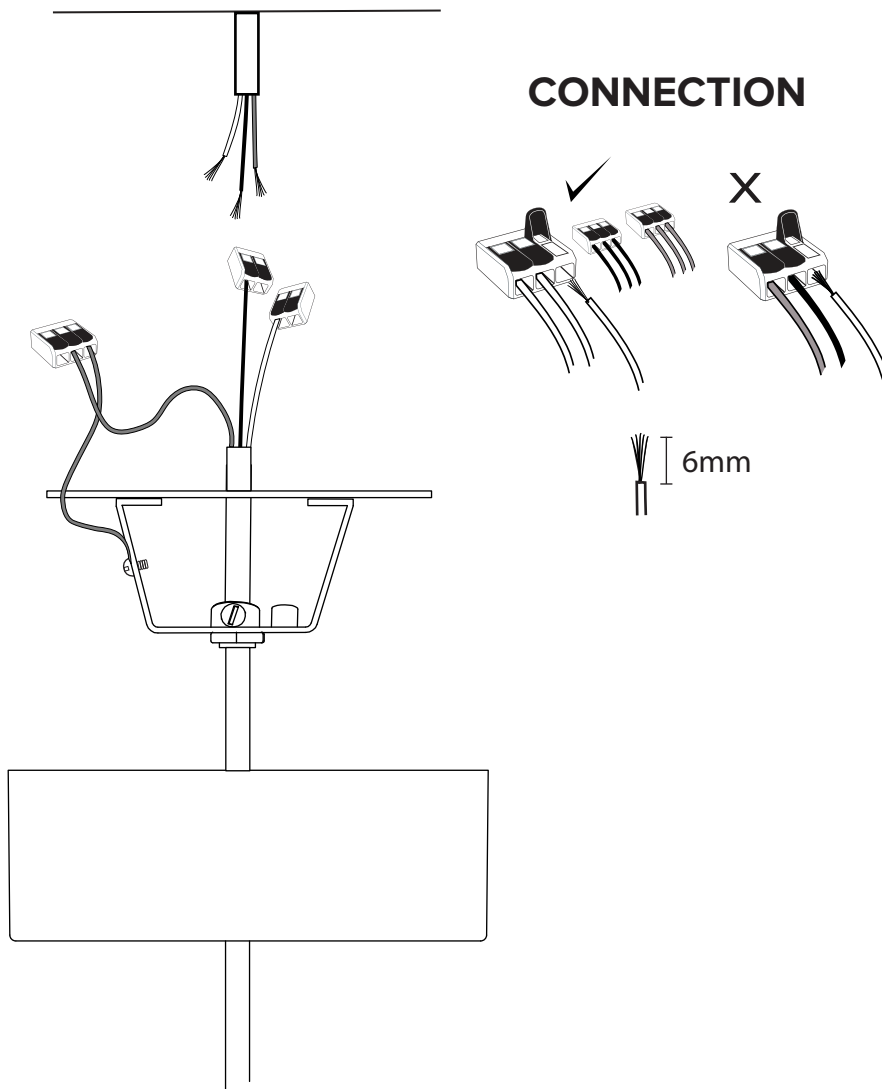

3

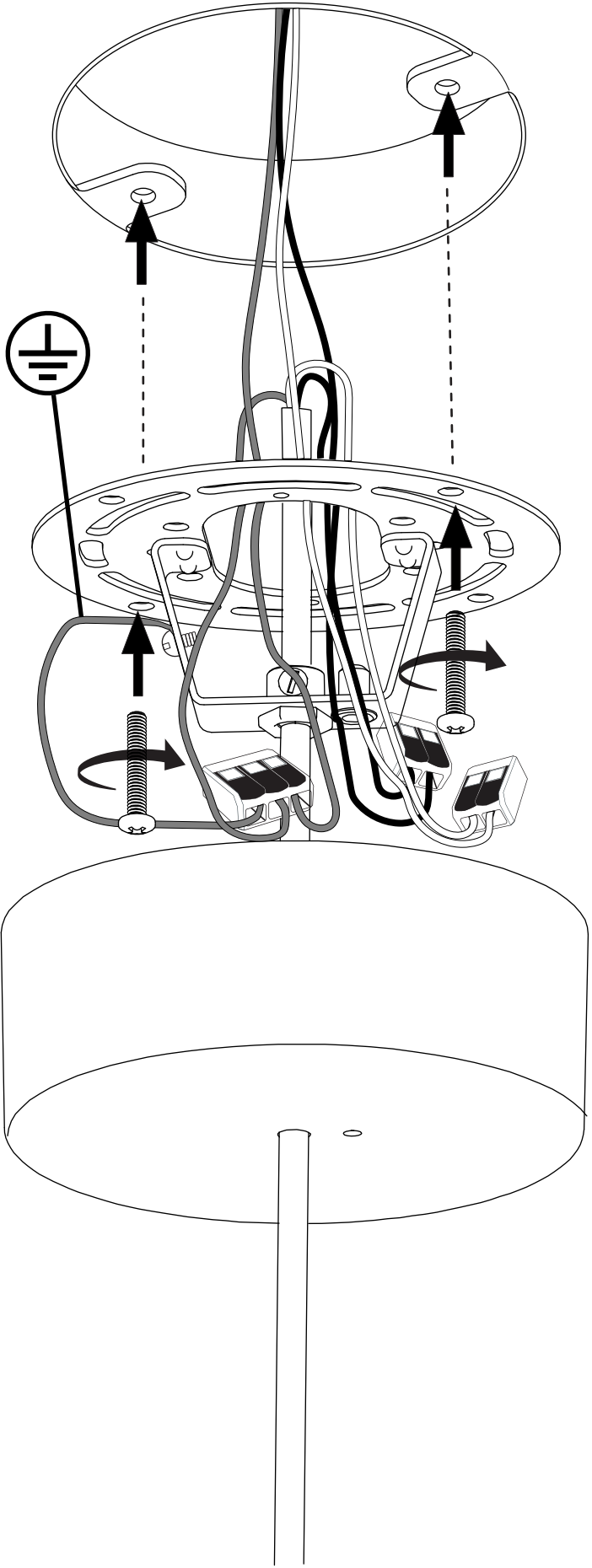

4

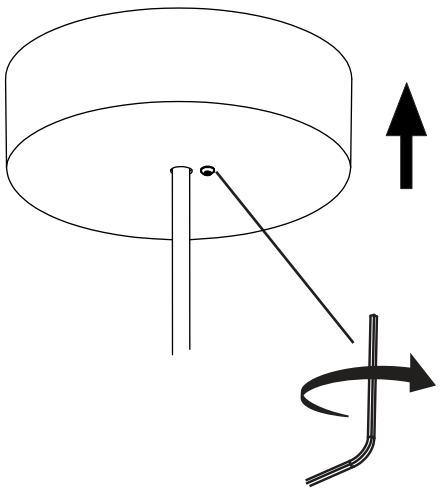

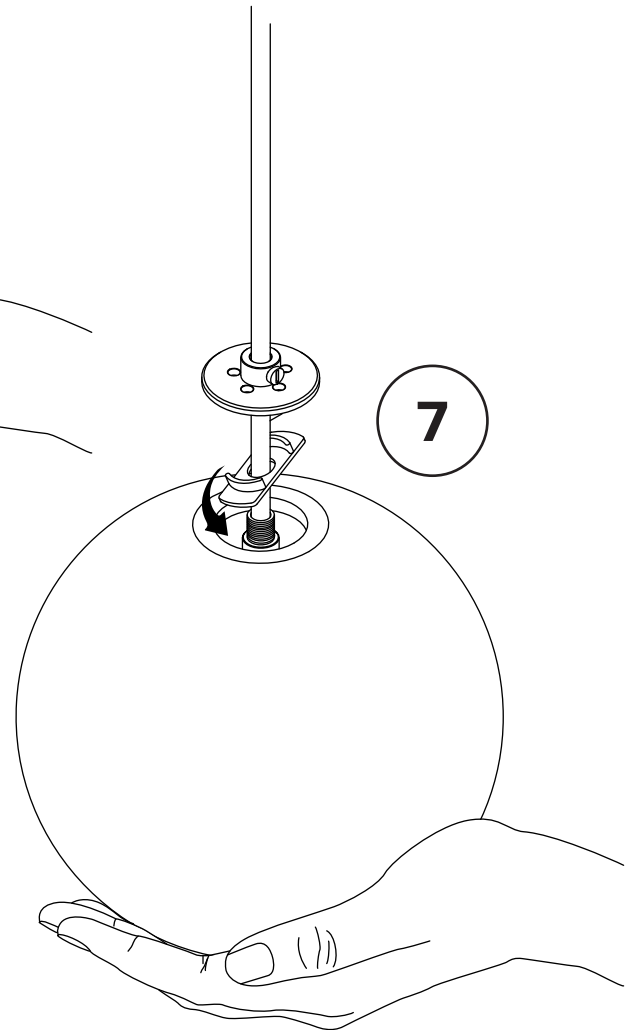
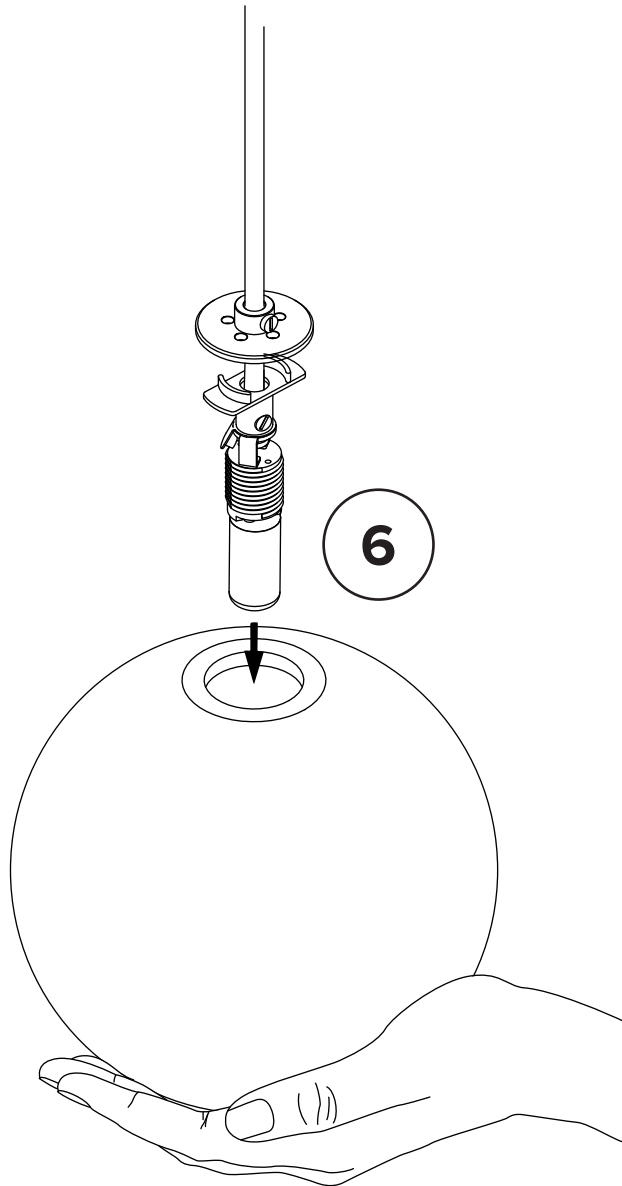
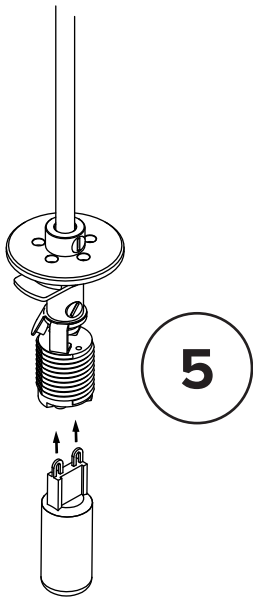

* To ensure safety,
**PLEASE FOLLOW THESE STEPS
CAREFULLY**

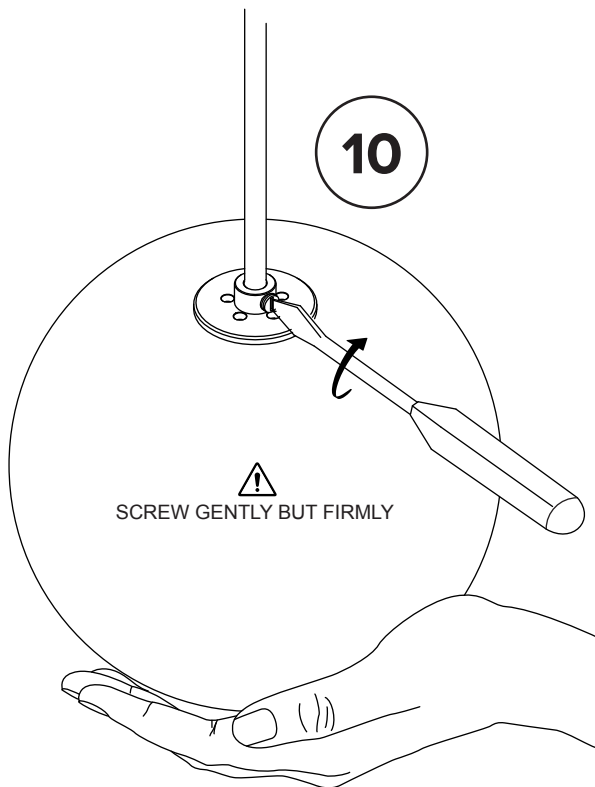
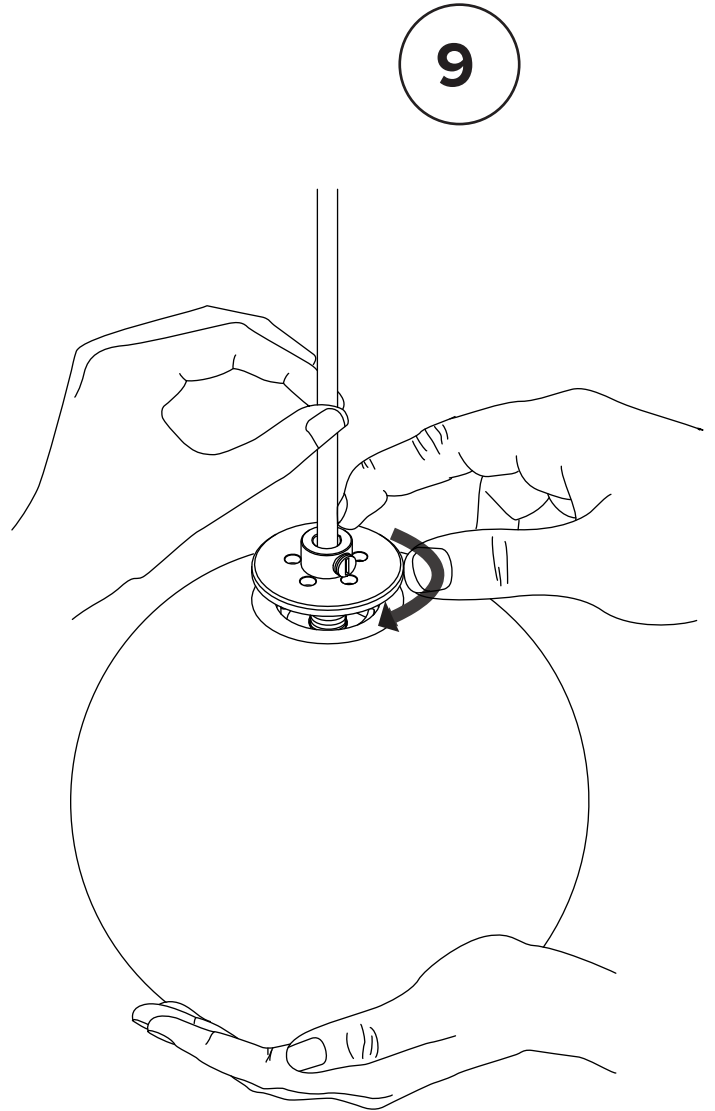
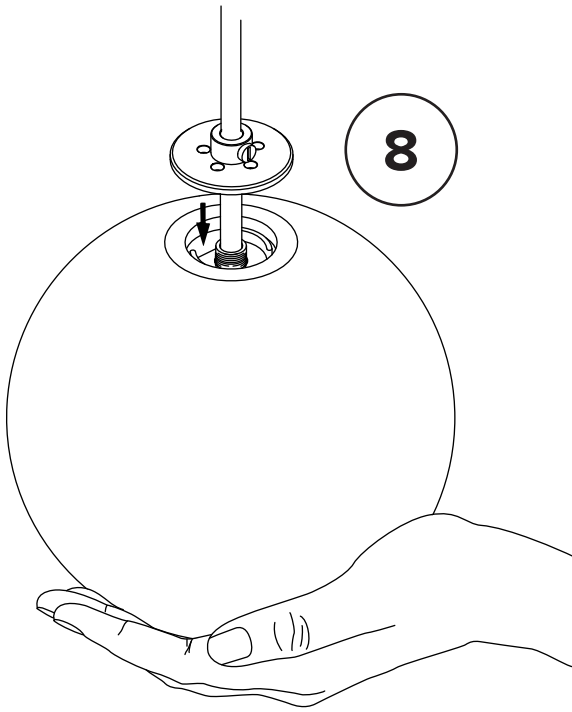

11

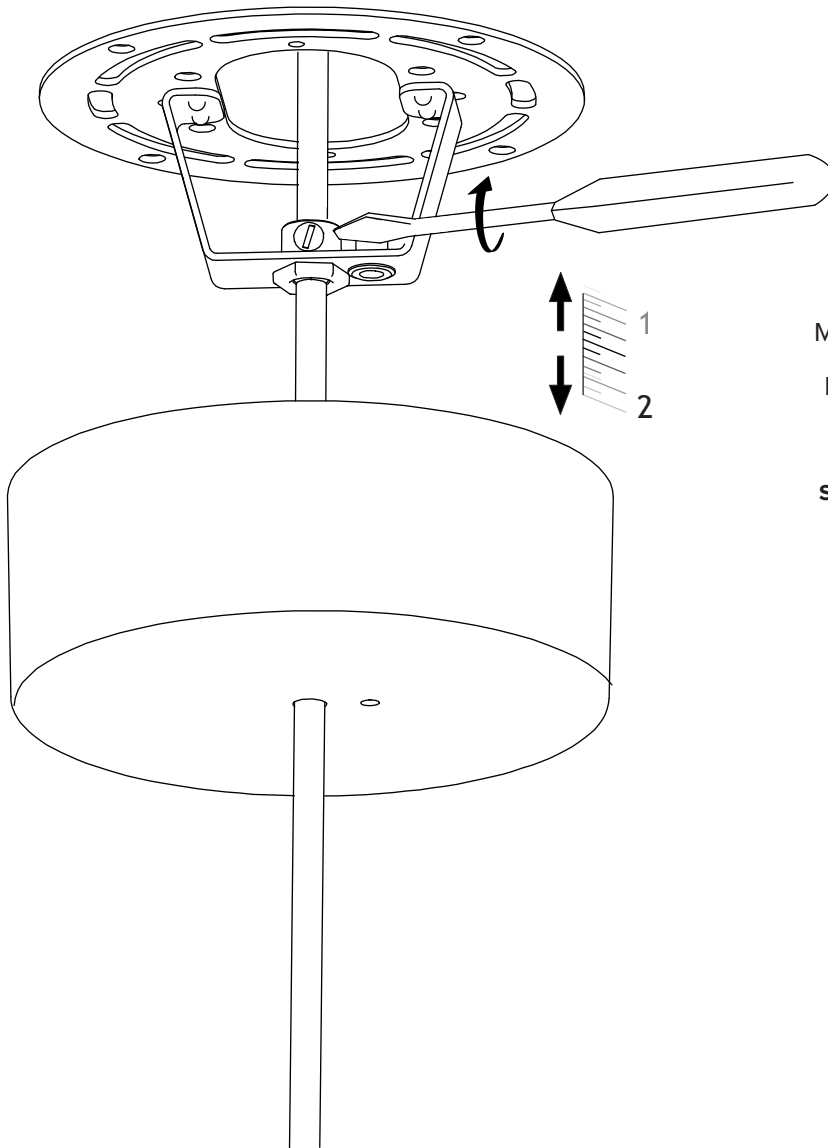

Make sure the globes are level by micro-adjusting the wire lengths.

SCREW GENTLY BUT FIRMLY

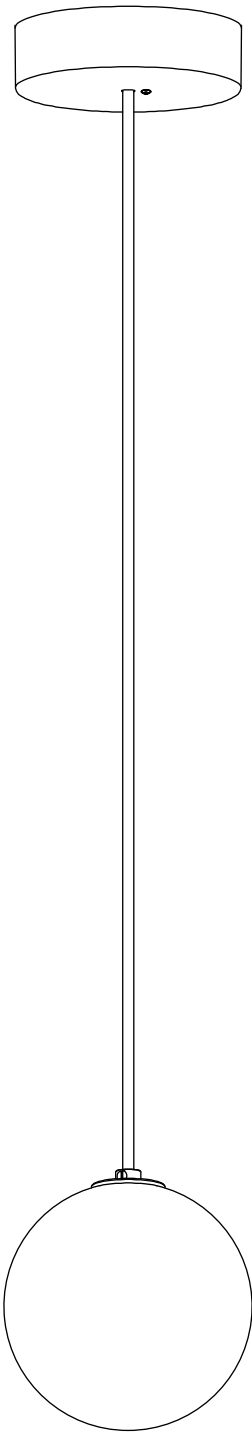

lambert&fils