





DOT TABLE



The Dot Collection combines the directness of exposed, spherical bulbs with the rich materiality of brass. Focused, geometric compositions contain these two features, balancing line, surface, and luminous points. The result is a collection of lamps based in the reflectivity of brass—lamps that are both atmospheric and firm.

TYPE	Table
CONSTRUCTION	Brass or powder coated steel and brass body Milk glass globes Polyester cord (vinyl cord for Australia)
SPECIFICATIONS	Source: LED lamp provided (G9 base) Power consumption: 4.5W Lumen output: 371lm Colour temperature: 2700K included * 3000K available upon request Colour rendering index: ≥ 90 CRI standard Expected lifetime: ≥ 25 000h
CORD LENGTH	96" / 244 cm, hand switch at 12" / 31 cm from lamp
WEIGHT	1.5 lb / 0.7 kg
CERTIFICATIONS	     IP20
WARRANTY	2 years

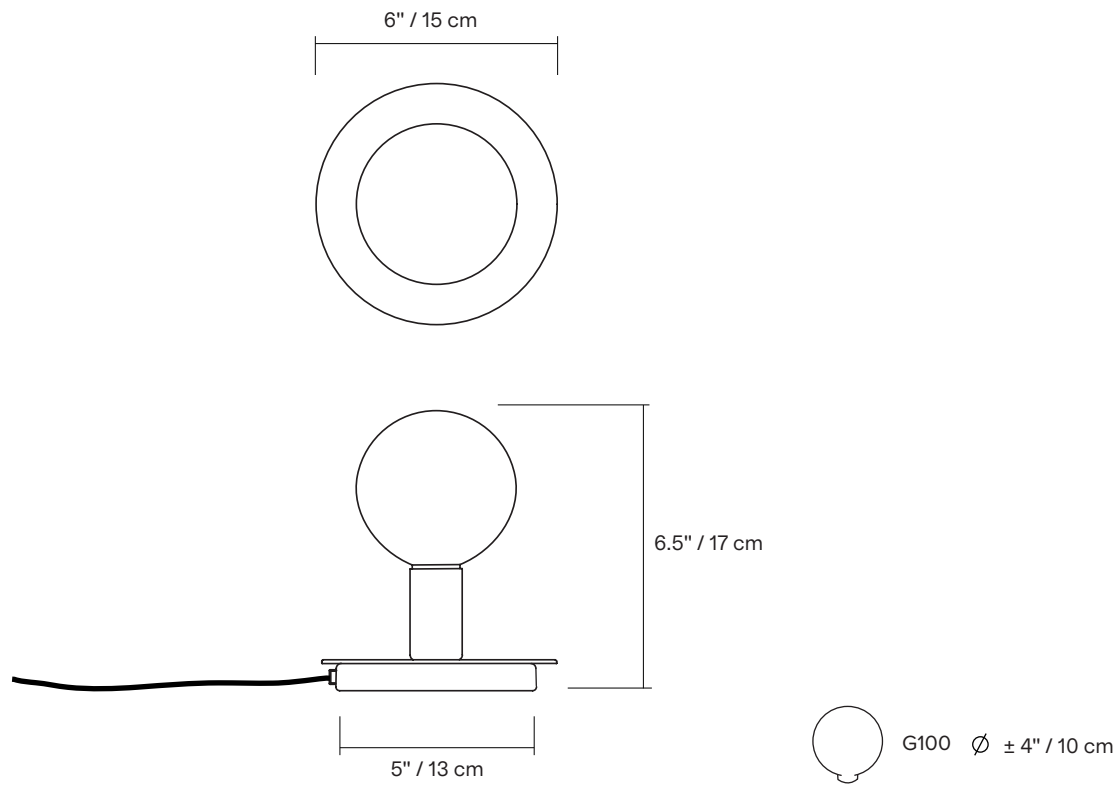

*dimensions are approximate and may vary slightly

FINISH



BR
Brass



BK
Textured
Black



WH
Textured
White



BG
Textured
Beige



MB
Textured
Midnight
Blue

CORD



BK
Black



WH
White



BG
Beige



MB
Midnight
Blue

NOTES

- Not protected against liquids (refer to IP20)
- Additional charges for modifications or for special orders
- Please refer to maintenance sheet on our website for cleaning instructions

LAMP ANATOMY

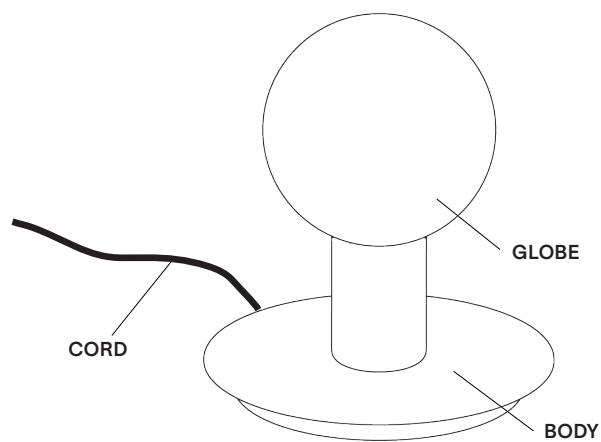

		Example	Fill with your selection
COLLECTION	DOT Dot	DOT	DOT
MODEL	04	04	04
BODY	BR Brass BK Textured Black WH Textured White BG Textured Beige MB Textured Midnight Blue CC Custom colour*	BR	
CORD**	BK Black WH White BG Beige MB Midnight Blue CC Custom colour*	BK	
FULL SKU		DOT04BRBK	
		NOTES	

*Custom colour available upon request. Material library on website.

**Cord only available in black or white vinyl for Australia.