





DOT ATOMIUM



The Dot Collection combines the directness of exposed, spherical bulbs with the rich materiality of brass. Focused, geometric compositions contain these two features, balancing line, surface, and luminous points. The result is a collection of lamps based in the reflectivity of brass—lamps that are both atmospheric and firm.

TYPE	Pendant
CONSTRUCTION	Brass body Milk glass globes
SPECIFICATIONS	Source: LED lamp provided (G9 base) Power consumption: 12 × 3.5W Lumen output: 3606lm Colour temperature: 2700K included * 3000K available upon request Colour rendering index: ≥ 90 CRI standard Expected lifetime: ≥ 25 000h
CONTROL	Refer to our recommended list of dimmer models
TOTAL HEIGHT	A: 24.5" B: 30.5" C: 36.5" D: 42.5" E: 54.5" 62cm 77cm 93cm 108cm 138cm
WEIGHT	Min. 5.5 lb / 2.5 Kg
CERTIFICATIONS	     IP20
WARRANTY	2 years

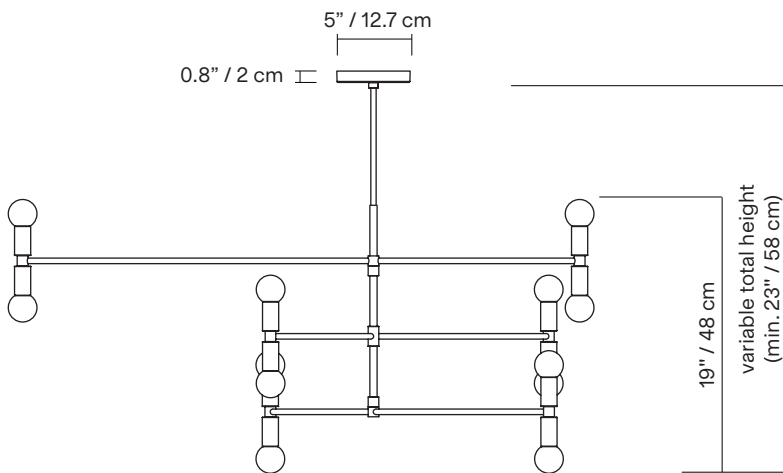
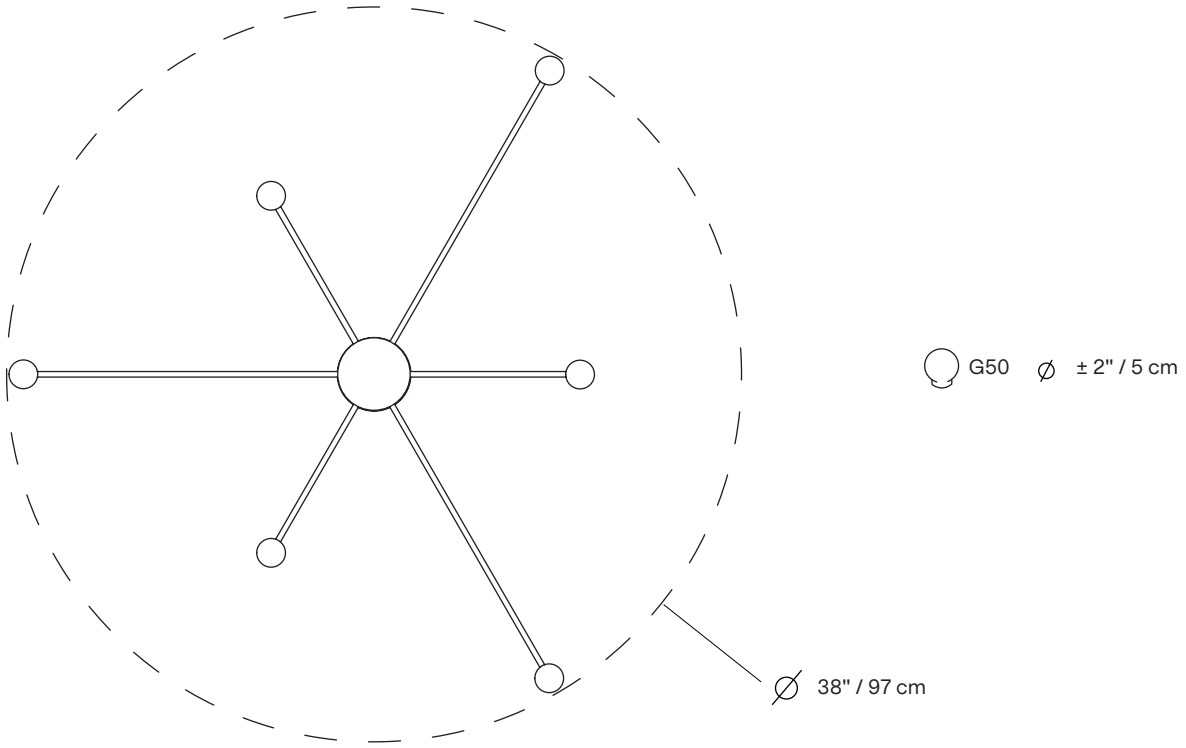

*dimensions are approximate and may vary slightly

FINISH



BR
Brass



GR
Graphite

CANOPY

Swivel option available for slanted ceiling

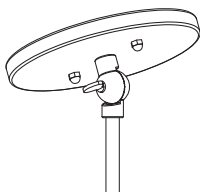

NOTES

- Must be installed by an electrician
- Not protected against liquids (refer to IP20)
- Additional charges for modifications or for special orders
- Please refer to maintenance sheet on our website for cleaning instructions

LAMP ANATOMY

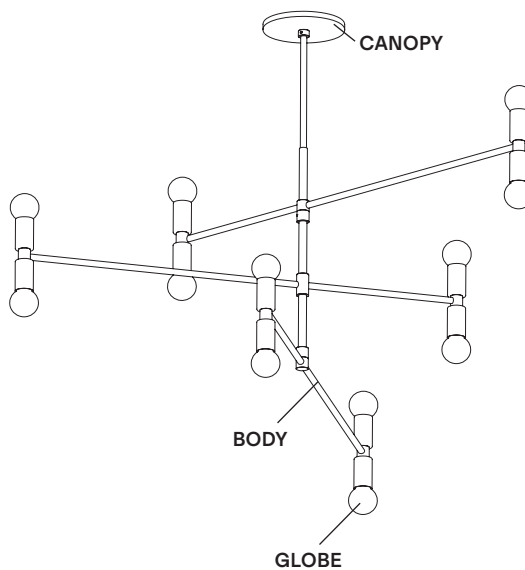

		Example	Fill with your selection
COLLECTION	DOT Dot	DOT	DOT
MODEL	01	01	01
FINISH	BR Brass GR Graphite	BR	
TOTAL HEIGHT	A 24.5" / 62 cm B 30.5" / 77 cm C 36.5" / 93 cm D 42.5" / 108 cm E 54.5" / 138 cm V Variable	A	
FULL SKU		DOT01BRA	
		NOTES	

DIMMER LIST COMPATIBILITY FOR G9 LED BULBS – 120V

The dimming technology offering the best results is ELV (electronic low voltage) dimmers with reverse phase or trailing edge control.

DIMMER BRAND	MODEL	MAX LEVEL	MIN LEVEL	DIMMING PROTOCOL
LUTRON - MAESTRO	MAELV-600	100%	0%	Phase Cut
LUTRON - SKYLARK	SELV-300P	100%	0%	Phase Cut
LUTRON - SKYLARK	SELV-300P	100%	0%	Phase Cut
LUTRON - SKYLARK	CTELV-303P	100%	0%	Phase Cut
LUTRON - DIVA	DVELV-300P	100%	0%	Phase Cut
LEGRAND - ADORNE	TRUE UNIVERSAL	100%	30%	Phase Cut

DIMMER LIST COMPATIBILITY FOR G9 LED BULBS – 230V

Phase cut dimming (leading edge or trailing edge**)

DIMMER BRAND	MODEL	MAX LEVEL	MIN LEVEL	DIMMING PROTOCOL
VARILIGHT	V-PRO	100%	2%	Phase Cut
LEGRAND - NILOÉ	3 996 35	87%	15%	Phase Cut
NIKO	310-0280X	94%	5%	Phase Cut
NIKO	310-0190X	100%	1%	Phase Cut

*Other dimmers can yield good results and we recommend conducting your own test before final installation.

Some dimmers require a minimum load, check specifications.

*Other dimmers that specify LED lamp compatibility may operate without issue.

We recommend conducting your own test before final installation.

**Leading edge is also known as TRIAC or Forward Phase.

Trailing edge is also known as ELV or Reverse Phase.
